

EOM

ENGINEERING OPERATION
& MAINTENANCE

A.025 Accu-Flo Clamped Metal Pump

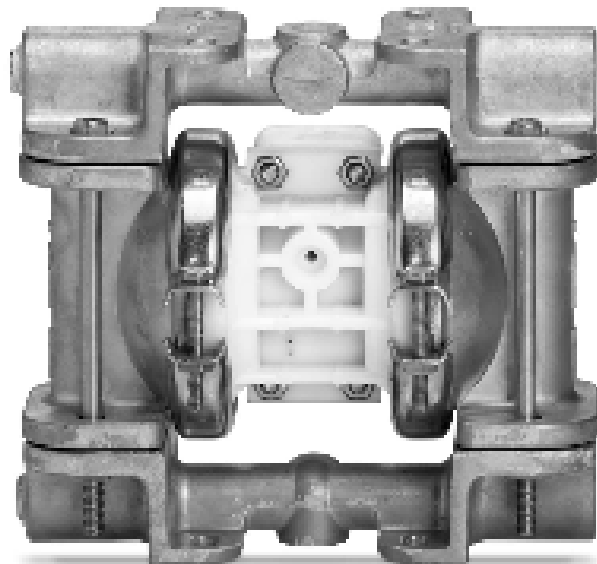

Where Innovation Flows

WILDEN®

airpumping.co.uk
of 1979  01708 259870

WIL-10030-E-03

Contents

Section 1: Precautions - Read First!	4
Section 2: Wilden Pump Designation System	5
Section 3: How It Works	6
Section 4: Dimensional Drawings	7
A.025T Metal (T-series Center Section).....	7
A.025B Metal (Adapter Block with T-series Center Section).....	7
A.025P Metal (P-series Center Section).....	8
A.025B Metal (Adapter Block with P-series Center Section).....	8
XA.025T Metal (T-Series Center Section).....	9
Section 5: Performance	10
A.025T Metal Rubber-Fitted (T-series Center Section).....	10
A.025T Metal PTFE-Fitted (T-series Center Section).....	10
A.025P Metal Rubber-Fitted (P-series Center Section).....	11
A.025P Metal PTFE-Fitted (P-series Center Section).....	11
70/30 Operating Conditions	12
A.025T Metal Rubber-Fitted (T-series Center Section).....	12
A.025T Metal PTFE-Fitted (T-series Center Section).....	12
A.025P Metal Rubber-Fitted (P-series Center Section).....	12
A.025P Metal PTFE-Fitted (P-series Center Section).....	12
Section 6: Suggested Installation, Operation, Maintenance and Troubleshooting	13
Section 7: Disassembly / Reassembly	16
Pump Disassembly.....	16
Reassembly Hints & Tips.....	19
Section 8: Exploded View and Parts List	20
A.025T Metal (T-series Center Section).....	20
A.025P Metal (P-series Center Section).....	22
Section 9: Elastomer Options/Electrical Information	25

Copyright

Copyright 2018 PSG®, a Dover Company. All rights reserved.

PSG reserves the right to modify the information and illustrations in this document without prior notice. The product described in this document is furnished under a license agreement or nondisclosure agreement. No part of this document may be reproduced, stored in a retrieval system, or transmitted in any form or any means electronic or mechanical, including photocopying and recording, without the written permission of PSG, a Dover Company, except as described by the terms of those agreements.

This is a non-contractual document. 01-2019.

Trademarks

PSG and the PSG logo are registered trademarks of PSG. Wilden® is a registered trademark of PSG California LLC. Pro-Flo® SHIFT and Pro-Flo® are registered trademarks of PSG California LLC. Wil-Flex® is a trademark of PSG California LLC. Saniflex™ is a trademark of PSG California LLC.

All trademarks, names, logos and service marks (collectively "trademarks") in this document are registered and unregistered trademarks of their respective owners. Nothing contained in this document should be construed as granting any license or right to use any trademark without the prior written permission of the trademark owner.

Warranty

Each and every product manufactured by Wilden is built to meet the highest standards of quality. Every pump is functionally tested to insure integrity of operation. Wilden warrants that pumps, accessories and parts manufactured or supplied by it to be free from defects in material and workmanship for a period of five (5) years from date of installation or six (6) years from date of manufacture, whichever comes first.

For more information, and to register your Wilden pump for warranty, please visit <https://www.psgdover.com/wilden/support/warranty-registration>.

Certifications

Section 1

Precautions - Read First!

 **TEMPERATURE LIMITS:**

PTFE Encap. FKM	4.4°C to 148.9°C	40°F to 300°F
Buna-N	-12.2°C to 82.2°C	10°F to 180°F
Wil-Flex™	-40°C to 107.2°C	-40°F to 225°F
PTFE	4.4°C to 148.9°C	40°F to 300°F

NOTE: Not all materials are available for all models. See "Wilden Pump Designation System on page 5 for material options for your pump.

 **CAUTION:** When choosing pump materials, be sure to check the temperature limits for all wetted components.

 **CAUTION:** Maximum temperature limits are based upon mechanical stress only. Certain chemicals will significantly reduce maximum safe operating temperatures. Consult engineering guide for chemical compatibility and temperature limits.

 **CAUTION:** Always wear safety glasses when operating pump. If diaphragm rupture occurs, material being pumped may be forced out air exhaust.

 **WARNING:** Prevention of static sparking — If static sparking occurs, fire or explosion could result. Pump, valves, and containers must be properly grounded when handling flammable fluids and whenever discharge of static electricity is a hazard.

 **CAUTION:** Do not exceed 8.6 bar (125 psig) air supply pressure.

 **CAUTION:** Before any maintenance or repair is attempted, the compressed air line to the pump should be disconnected and all air pressure allowed to bleed from pump. Disconnect all intake, discharge and air lines. Drain the pump by turning it upside down and allowing any fluid to flow into a suitable container.

 **CAUTION:** Blow out air line for 10 to 20 seconds before attaching to pump to make sure all pipe line debris is clear. Use an in-line air filter. A 5µ (micron) air filter is recommended.

 **NOTE:** Tighten clamp bands prior to installation. Fittings may loosen during transportation.

 **NOTE:** Before starting disassembly, mark a line from each liquid chamber to its corresponding air chamber. This line will assist in proper alignment during reassembly.

 **CAUTION:** Verify the chemical compatibility of the process and cleaning fluid to the pump's component materials in the Chemical Resistance Guide (see E4).

 **CAUTION:** Only explosion proof (NEMA 7) solenoid valves should be used in areas where explosion proof equipment is required.

 **CAUTION:** The A.025 Pump is not submersible.

 **CAUTION:** Pump performance will be seriously hampered if pump is installed upside down.

Section 2

WILDEN PUMP DESIGNATION SYSTEM

**A.025 ORIGINAL™
METAL**

**6 mm (1/4") Pump
Maximum Flow Rate:
13.3 lpm (3.5 gpm)**

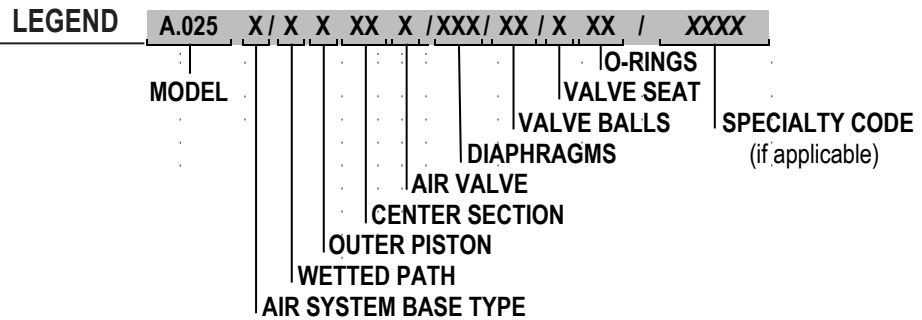

MATERIAL CODES

<p>MODEL A.025 =METAL ACCU-FLO™</p> <p>AIR SYSTEM BASE TYPE B = ADAPTER BLOCK P = PRO-FLO® T = TURBO-FLO™</p> <p>WETTED PATH A = ALUMINUM H = ALLOY C S = STAINLESS STEEL</p> <p>OUTER PISTON A = ALUMINUM H = ALLOY C S = STAINLESS STEEL Z = NO PISTON</p>	<p>CENTER SECTION PP = POLYPROPYLENE LL = ACETAL</p> <p>AIR VALVE A = ALUMINUM (Available on A.025T only) L = ACETAL (Available for A.025B and A.025P only) P = POLYPROPYLENE (Available for A.025B and A.025P only) U = UHMW PE (Available for A.025B only)</p> <p>DIAPHRAGMS BNS = BUNA-N (Red Dot) TNL = PTFE W/NEOPRENE BACKUP O-RING, IPD (White) WFS = WIL-FLEX™ [Santoprene® (Orange Dot)]</p>	<p>VALVE BALLS TF = PTFE (White)</p> <p>VALVE SEATS A = ALUMINUM H = ALLOY C S = STAINLESS STEEL</p> <p>VALVE SEAT O-RINGS BN = BUNA-N TF = PTFE (White) TV = PTFE ENCAP. FKM WF = WIL-FLEX™ (Santoprene®)</p> <p>MANIFOLD O-RINGS BN = BUNA-N TF = PTFE (White)</p>
--	--	--

SPECIALTY CODES

0150 Accu-Flo™, 24V DC coil	0169 Accu-Flo™, 110V AC coil, PFA coated hardware	0184 Accu-Flo™, 24V DC coil, PFA coated hardware
0151 Accu-Flo™, 24V AC / 12V DC coil	0170 Accu-Flo™, 110V AC x-proof coil, PFA coated hardware	0185 Accu-Flo™, 24V DC x-proof coil, PFA coated hardware
0153 Accu-Flo™, 24V AC / 12V DC x-proof coil	0180 Accu-Flo™, 24V AC / 12V DC coil, PFA coated hardware	0675 Accu-Flo™, 24V DC, inlet manifold, dual ported, NPT
0154 Accu-Flo™, 24V DC x-proof coil	0181 Accu-Flo™, 24V AC / 12V DC x-proof coil, PFA coated hardware	0676 Accu-Flo™, 24V DC, inlet manifold, dual ported, BSPT
0155 Accu-Flo™, 110V coil		
0156 Accu-Flo™, 110V AC x-proof coil		
0157 Accu-Flo™, 24V DC x-proof coil, Intl., PTB approved		

THE THREE ACCU-FLO™ OPTIONS AVAILABLE:

- AxT:** This is the same Accu-Flo™ configuration that has been available from Wilden since March 1994. An aluminum solenoid valve is attached directly to a T-series center section and the shaft/inner piston configuration is altered.
- AxP:** This option uses a plastic (polypropylene or acetal) spacer that is assembled between the Pro-Flo® air valve and the Pro-Flo® center section. The same solenoid operator – coil assembly that is found on AxT pumps is assembled on the plastic spacer discussed above for electronic interface. This spacer together with the Pro-Flo® air valve replaces the aluminum air valve used in the AxT with a more chemically resistant option. Spacers will be available in the 1/4", 1/2", and 1" sizes.

The use of the Pro-Flo® ADS provides additional flow in most applications (refer to EOM for details). The AxP provides the Pro-Flo® benefits of lower start-up pressure, reduced blow-by, and increased life.

- AxB:** This option uses an Adapter Block in place of an air valve. A user supplied, 4-way pneumatic valve must be used in conjunction with this technology. This configuration enables the solenoid valve to be remotely installed, preventing chemical attack in very aggressive environments. Adapter Blocks are available for both the T and P series center sections in all pump sizes. (See EOM AxB for details.)

NOTE: The "x" in the above Accu-Flo™ descriptions are used in place of a pump model size. See Pump Designation System chart above.

NOTE: Most elastomeric materials use colored dots for identification.

NOTE: Not all models are available with all material options.

Santoprene® is a registered trademark of Monsanto Company, licensed to Advanced Elastomer Systems, L.P.

Section 3

HOW IT WORKS — PUMP

The Wilden diaphragm pump is an air-operated, positive displacement, self-priming pump. These drawings show the flow pattern through the pump upon its initial stroke. It is assumed the pump has no fluid in it prior to its initial stroke.

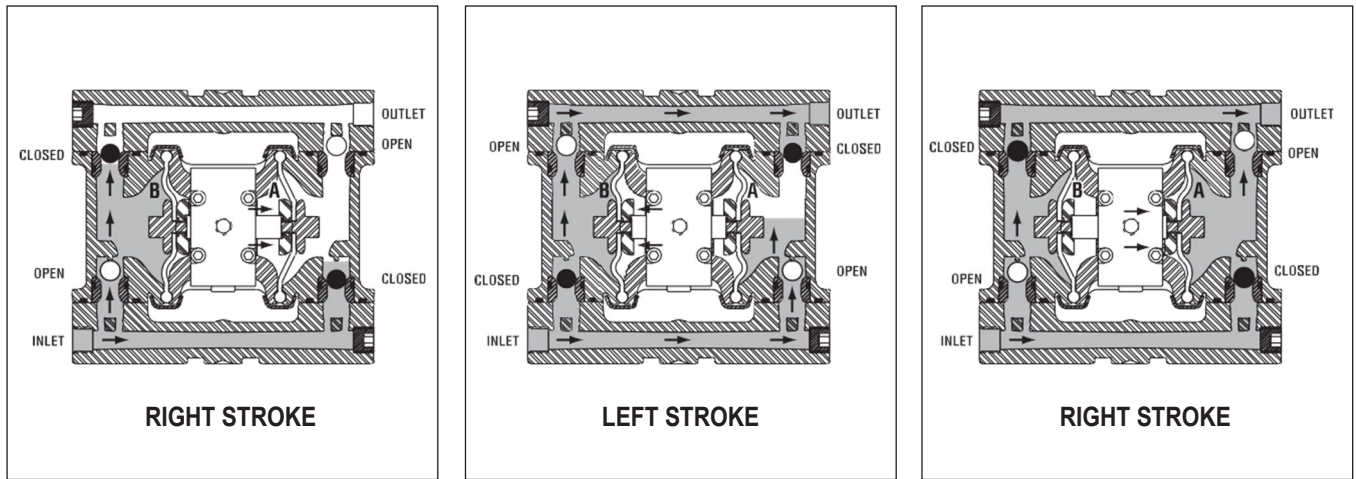

FIGURE 1 When the solenoid is energized, the air valve directs pressure to the back side of diaphragm A. The compressed air is applied directly to the liquid column separated by elastomeric diaphragms. The diaphragm acts as a membrane between the compressed air and the liquid, balancing the load and removing mechanical stress from the diaphragm. The compressed air moves the diaphragm away from the center section of the pump. The opposite diaphragm is pulled in by the shaft connected to the pressurized diaphragm. Diaphragm B is on its suction stroke; air behind the diaphragm has been forced out to the atmosphere through the exhaust port. The movement of diaphragm B toward the center section of the pump creates a vacuum within chamber B. Atmospheric pressure forces fluid into the inlet manifold forcing the inlet valve ball off of its seat. Liquid is free to move past the inlet valve ball and fill the liquid chamber (see shaded area).

FIGURE 2 When the solenoid valve is deenergized, the air valve redirects pressurized air to the back side of diaphragm B. The pressurized air forces diaphragm B away from the center section while pulling diaphragm A to the center section. Diaphragm B is now on its discharge stroke. Diaphragm B forces the inlet valve ball onto its seat due to the hydraulic forces developed in the liquid chamber and manifold of the pump. These same hydraulic forces lift the discharge valve ball off of its seat, while the opposite discharge valve ball is forced onto its seat, forcing fluid to flow through the pump discharge. The movement of diaphragm A toward the center section of the pump creates a vacuum within liquid chamber A. Atmospheric pressure forces fluid into the inlet manifold of the pump. The inlet valve ball is forced off of its seat allowing the fluid being pumped to fill the liquid chamber.

FIGURE 3 Once the solenoid valve is reenergized the air is directed to the back side of diaphragm A, which starts diaphragm B on its exhaust stroke. As the pump reaches its original starting point, each diaphragm has gone through one intake and one discharge stroke. This constitutes one complete pumping cycle. The pump may take several cycles to completely prime depending on the conditions of the application.

Section 4

DIMENSIONAL DRAWING

A.025T Metal Accu-Flo™

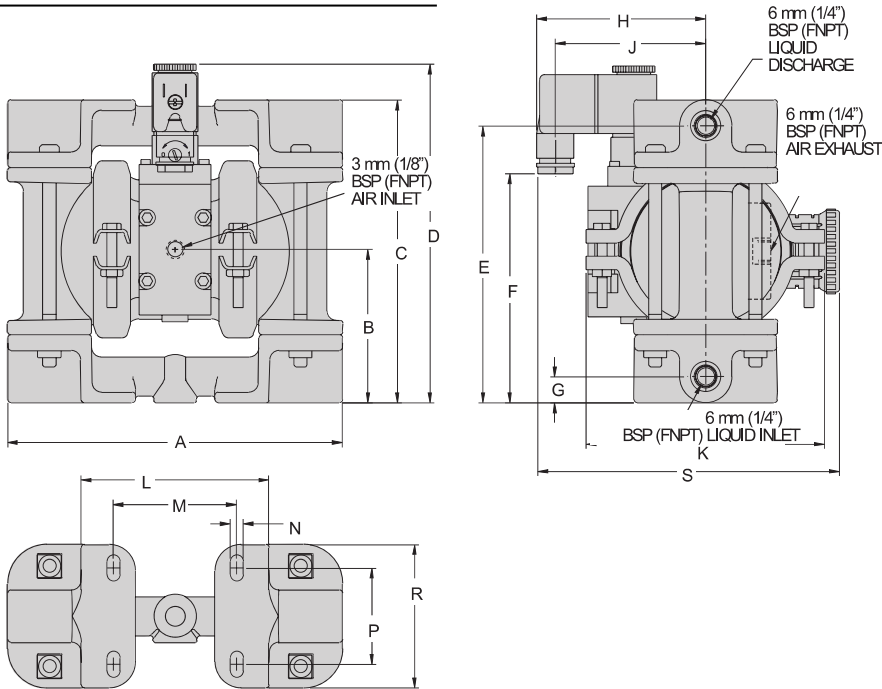

DIMENSIONS

ITEM	METRIC (mm)	STANDARD (inch)
A	165	6.5
B	74	2.9
C	147	5.8
D	140	5.5
E	135	5.3
F	107	4.2
G	13	0.5
H	97	3.8
J	74	2.9
K	114	4.5
L	91	3.6
M	61	2.4
N	8	0.3
P	46	1.8
R	71	2.8
S	147	5.8

A.025B Metal (P-Series Center Section)

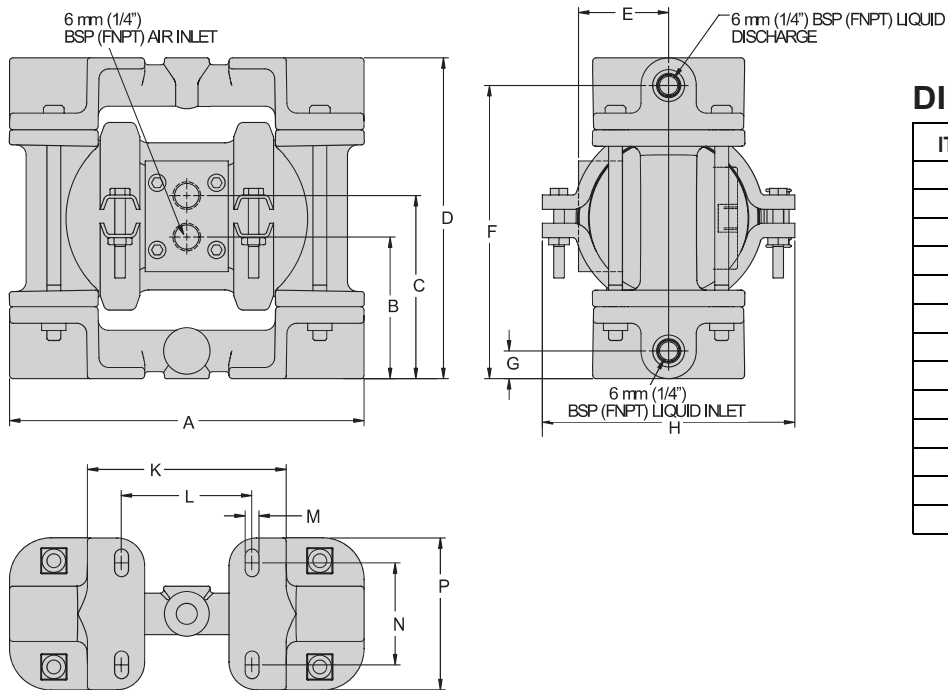

DIMENSIONS

ITEM	METRIC (mm)	STANDARD (inch)
A	165	6.5
B	66	2.6
C	84	3.3
D	147	5.8
E	41	1.6
F	135	5.3
G	13	0.5
H	114	4.5
K	91	3.6
L	61	2.4
M	8	0.3
N	46	1.8
P	71	2.8

DIMENSIONAL DRAWING

A.025P Metal Accu-Flo™

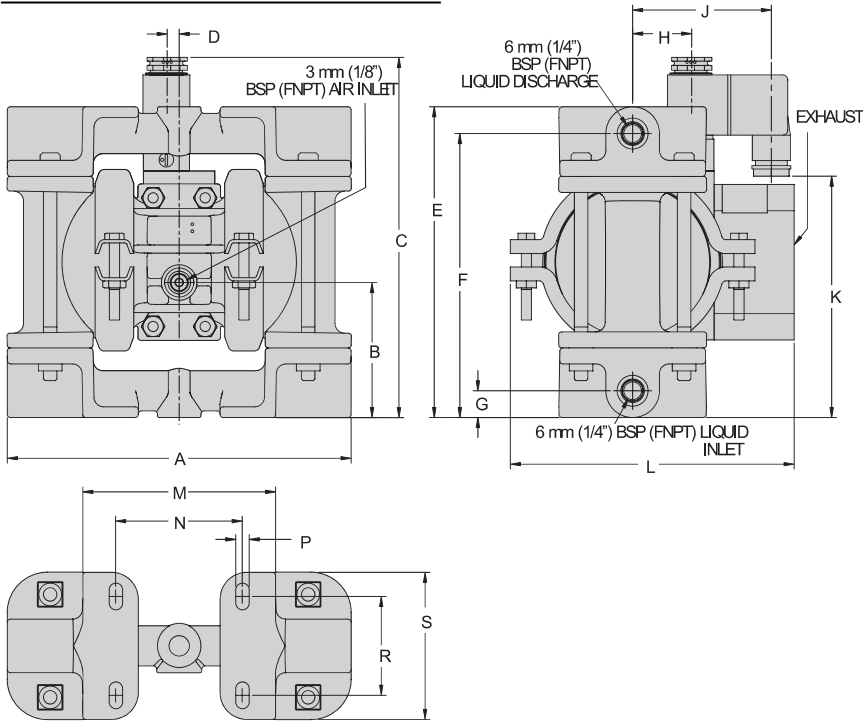

DIMENSIONS

ITEM	METRIC (mm)	STANDARD (inch)
A	165	6.5
B	64	2.5
C	170	6.7
D	8	0.3
E	147	5.8
F	135	5.3
G	13	0.5
H	28	1.1
J	66	2.6
K	114	4.5
L	135	5.3
M	91	3.6
N	61	2.4
P	8	0.3
R	46	1.8
S	71	2.8

A.025B Metal (P-Series Center Section)

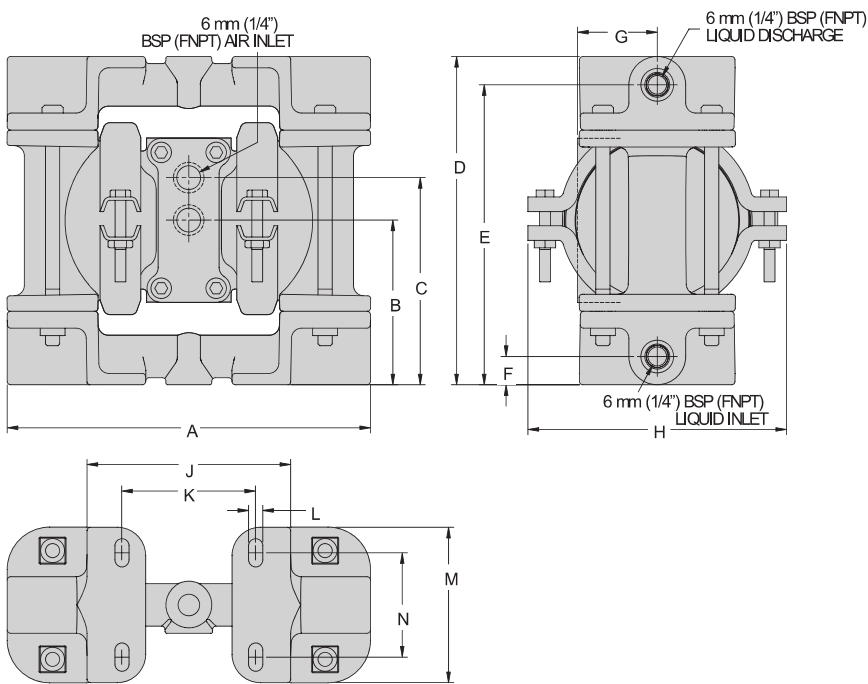

DIMENSIONS

ITEM	METRIC (mm)	STANDARD (inch)
A	165	6.5
B	74	2.9
C	94	3.7
D	147	5.8
E	135	5.3
F	13	0.5
G	36	1.4
H	114	4.5
J	91	3.6
K	61	2.4
L	8	0.3
M	71	2.8
N	46	1.8

DIMENSIONAL DRAWING

XA.025T Metal (T-Series Center Section)

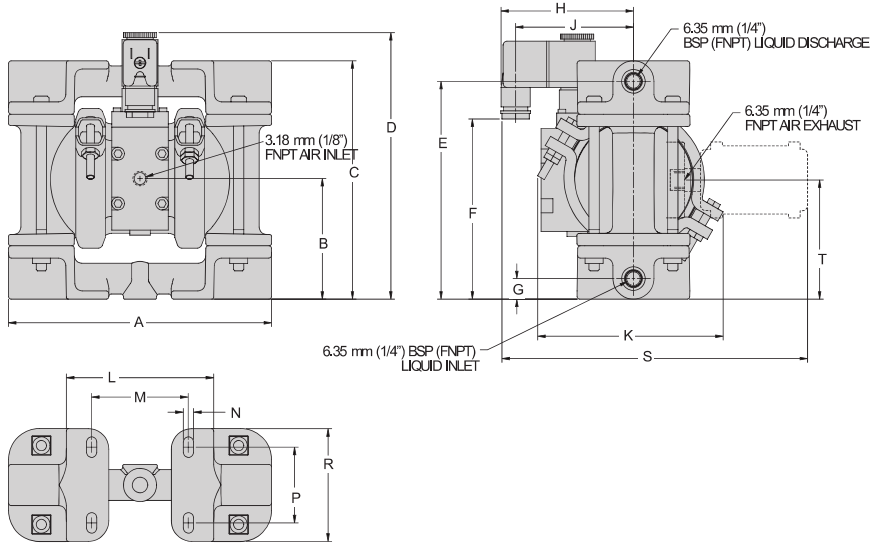

DIMENSIONS

ITEM	METRIC (mm)	STANDARD (inch)
A	165	6.5
B	74	2.9
C	147	5.8
D	165	6.5
E	135	5.3
F	107	4.2
G	13	0.5
H	97	3.8
J	74	2.9
K	114	4.5
L	91	3.6
M	61	2.4
N	8	0.3
P	46	1.8
R	71	2.8
S	191	7.5
T	74	2.9

Section 5

PERFORMANCE

A.025 METAL RUBBER-FITTED

Height 140 mm (5.5")
 Width 165 mm (6.5")
 Depth 147 mm (5.8")
 Est. Ship Weight Aluminum 2 kg (5 lbs)
 Stainless Steel 5 kg (11 lbs)
 Alloy C 5 kg (12 lbs)
 Air Inlet 3 mm (1/8")
 Inlet 6 mm (1/4")
 Outlet 6 mm (1/4")
 Suction Lift 5.36 m (17.6' Dry)
 10.02 m (32.9' Wet)
 Disp. Per Stroke 0.24 l (.006 gal.)
 Max. Flow Rate 16.3 lpm (4.3 gpm)
 Max. Size Solids 0.4 mm (1/64")

Example: To pump 3.8 lpm (1 gpm) against a discharge pressure head of 3.6 bar (52 psig) requires 4.1 bar (60 psig) and 2.7 Nm³/h (1.6 scfm) air consumption

Caution: Do not exceed 8.6 bar (125 psig) air supply pressure.

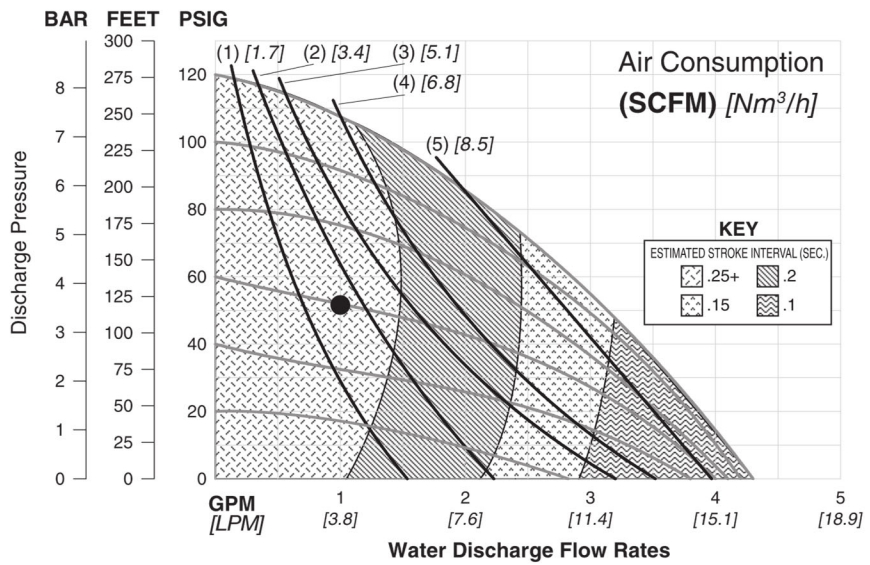

Flow rates indicated on chart were determined by pumping water.

For optimum life and performance, pumps should be specified so that daily operation parameters will fall in the center of the pump performance curve.

A.025 METAL PTFE-FITTED

Height 140 mm (5.5")
 Width 165 mm (6.5")
 Depth 147 mm (5.8")
 Est. Ship Weight Aluminum 2 kg (5 lbs)
 Stainless Steel 5 kg (11 lbs)
 Alloy C 5 kg (12 lbs)
 Air Inlet 3 mm (1/8")
 Inlet 6 mm (1/4")
 Outlet 6 mm (1/4")
 Suction Lift 4.32 m (14.2' Dry)
 10.02 m (32.9' Wet)
 Disp. Per Stroke 0.017 l (.005 gal.)
 Max. Flow Rate 14.0 lpm (3.7 gpm)
 Max. Size Solids 0.4 mm (1/64")

Example: To pump 3.8 lpm (1 gpm) against a discharge pressure head of 3.4 bar (50 psig) requires 4.1 bar (60 psig) and 4.08 Nm³/h (2.4 scfm) air consumption.

Caution: Do not exceed 8.6 bar (125 psig) air supply pressure.

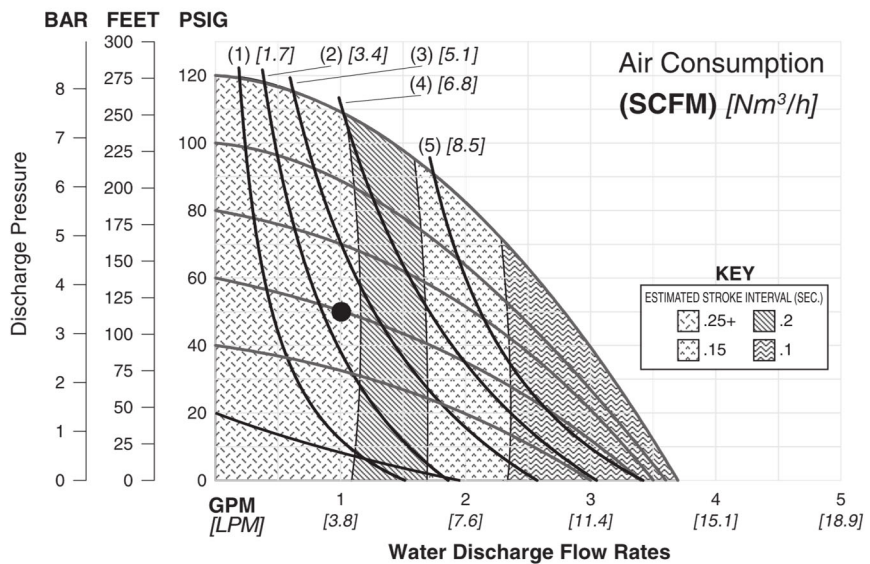

Flow rates indicated on chart were determined by pumping water.

For optimum life and performance, pumps should be specified so that daily operation parameters will fall in the center of the pump performance curve.

PERFORMANCE

A.025P METAL RUBBER-FITTED

Height 170 mm (6.7")
 Width 165 mm (6.5")
 Depth 135 mm (5.3")
 Est. Ship Weight Aluminum 2 kg (5 lbs)
 Stainless Steel 5 kg (11 lbs)
 Alloy C 5 kg (12 lbs)
 Air Inlet 3 mm (1/8")
 Inlet 6 mm (1/4")
 Outlet 6 mm (1/4")
 Suction Lift 4.49 m (14.7' Dry)
 9.33 m (30.6' Wet)
 Disp. Per Stroke 0.019 l (.005 gal.)
 Max. Flow Rate 15.5 lpm (4.1 gpm)
 Max. Size Solids 0.4 mm (1/64")

Example: To pump 3.8 lpm (1 gpm) against a discharge pressure head of 3.0 Bar (44 psig) requires 4.1 Bar (60 psig) and 2.72 Nm³/h (1.6 scfm) air consumption.

Caution: Do not exceed 8.6 Bar (125 psig) air supply pressure.

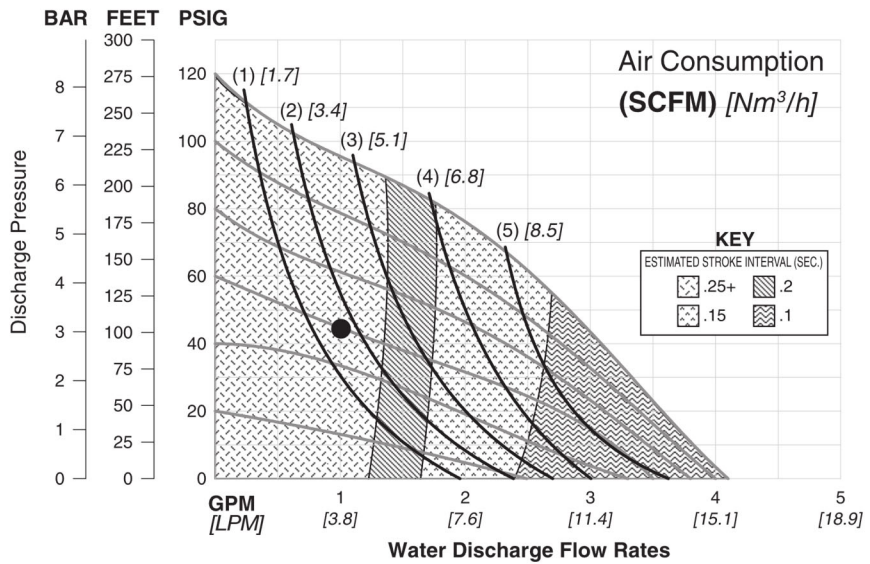

Flow rates indicated on chart were determined by pumping water.

For optimum life and performance, pumps should be specified so that daily operation parameters will fall in the center of the pump performance curve.

A.025 METAL PTFE-FITTED

Height 170 mm (6.7")
 Width 165 mm (6.5")
 Depth 135 mm (5.3")
 Est. Ship Weight Aluminum 2 kg (5 lbs)
 Stainless Steel 5 kg (11 lbs)
 Alloy C 5 kg (12 lbs)
 Air Inlet 3 mm (1/8")
 Inlet 6 mm (1/4")
 Outlet 6 mm (1/4")
 Suction Lift 3.80 m (12.5' Dry)
 9.33 m (30.6' Wet)
 Disp. Per Stroke 0.02 l (.005 gal.)
 Max. Flow Rate 15.1 lpm (4.0 gpm)
 Max. Size Solids 0.4 mm (1/64")

Example: To pump 3.8 lpm (1 gpm) against a discharge pressure head of 3.1 bar (45 psig) requires 4.1 bar (60 psig) and 4.93 Nm³/h (2.9 scfm) air consumption.

Caution: Do not exceed 8.6 bar (125 psig) air supply pressure.

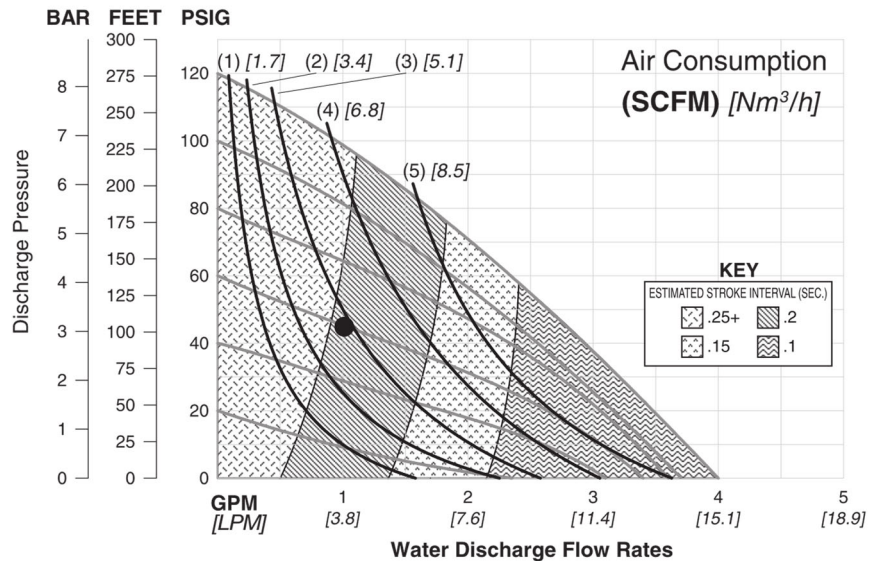

Flow rates indicated on chart were determined by pumping water.

For optimum life and performance, pumps should be specified so that daily operation parameters will fall in the center of the pump performance curve.

70/30 OPERATING CONDITIONS

A.025T METAL ACCU-FLO™

These curves demonstrate the flow created when the stroke rate is modified under static air and fluid pressure condition. This curve can be applied to different pressure conditions to estimate the change in flow due to stroke rate.

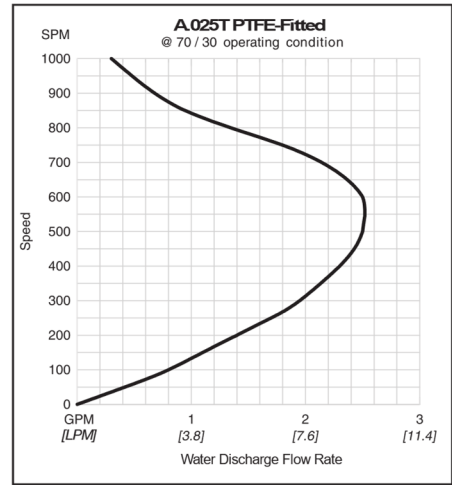
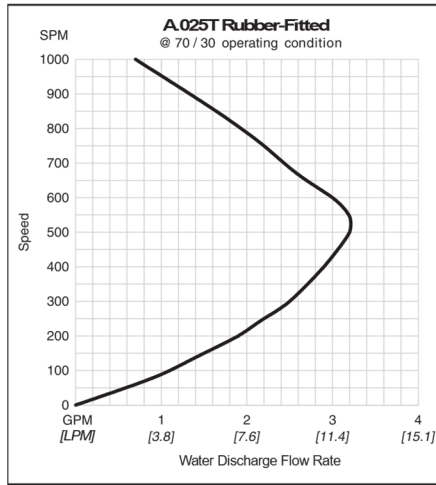

A.025P METAL ACCU-FLO™

These curves demonstrate the flow created when the stroke rate is modified under static air and fluid pressure condition. This curve can be applied to different pressure conditions to estimate the change in flow due to stroke rate.

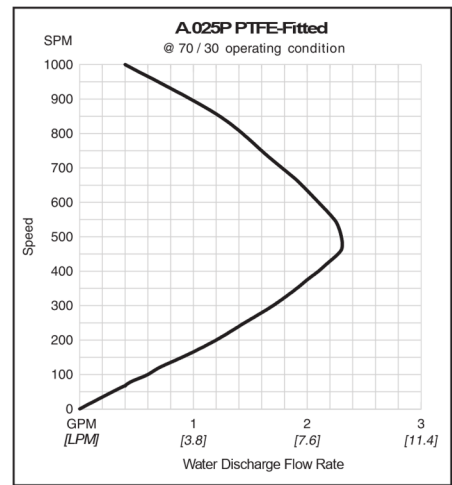
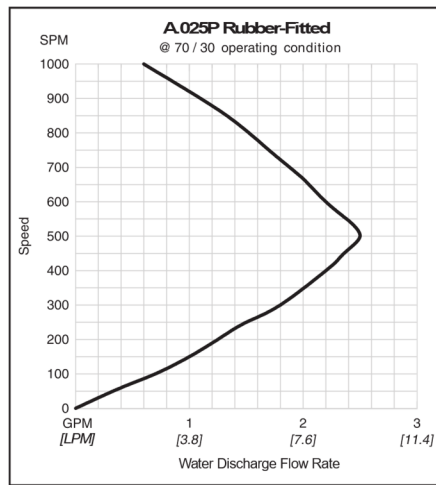

Section 6

Suggested Installation, Operation, Maintenance and Troubleshooting

All Wilden pumps are manufactured with a variety of materials for the air distribution system, liquid path and elastomers. This variety is offered to satisfy the temperature, chemical compatibility, abrasion and flex life requirements for most applications. Consult manual for available materials and temperature limitations for this pump model.

For Accu-Flo™ models only, all wiring used to operate the pump should be placed and connected according to all applicable electrical codes. It is important that the wiring be of adequate gauge to carry the current required to operate the pump. In addition, it is necessary that the electrical power supply be large enough to supply the current required to operate the pump. Wiring should be above ground level if possible (in case of fluid spill or leakage), and all wiring and connections which could become wet or damp should be made watertight.

The suction pipe used for installation should be sized equal to, or greater than, the pump liquid inlet connection. This will minimize pump cavitation and potential blockages of the pump inlet. The discharge piping should also be sized equal to, or greater than, the pump liquid discharge connection. If the pump is to be used in a self-priming application, be sure that all connections are airtight and that the suction lift is within the pump's ability. (Consult manual for suction lift information.)



NOTE: Materials of construction and elastomer materials have an effect on suction lift parameters.

Installation

Months of careful planning, study and selection efforts can result in unsatisfactory pump performance if installation details are left to chance. Premature failure and long term dissatisfaction can be avoided if reasonable care is exercised throughout the installation process.

Location

Noise, safety, and other logistical factors usually dictate that "utility" equipment be situated away from the production floor. Multiple installations with conflicting requirements can result in congested utility areas, leaving few choices for siting additional pumps.

Within the framework of these and other existing conditions, every pump should be located in such a way that four key factors are balanced against each other to maximum advantage:

- **Access:** First of all, the location should be accessible. If it is easy to reach the pump, maintenance personnel will have an easier time carrying out routine inspections and adjustments. Should major repairs become necessary, ease of access can play a key role in speeding the repair process and reducing total downtime.
- **Air Supply:** Every pump location should have an air line large enough to supply the volume of air necessary to achieve the desired pumping rate. (Consult manual for performance information.) The use of an air filter before the pump will ensure that the majority of pipeline contaminants will be eliminated. For best results, the pump should use an air filter, regulator system.

Sound levels are reduced below OSHA specifications using the standard Wilden muffler.

- **Elevation:** Selecting a site that is well within the pump's dynamic lift capability will assure that a loss-of-prime condition will be avoided. In addition, pump efficiency can be adversely effected if proper attention is not given to site location.

- **Piping:** Final determination of the pump site should not be made until the piping problems of each possible location have been evaluated. The impact of current and future installations should be considered ahead of time to make sure that inadvertent restrictions are not created for any remaining sites.

The best choice possible will be a site involving the shortest and straightest hook-up of suction and discharge piping. Unnecessary elbows, bends, and fittings should be avoided. Pipe sizes should be selected so as to keep friction losses within practical limits. All piping should be supported independently of the pump to avoid damage. In addition, the piping should be aligned so as to avoid placing stress on the pump fittings.

Flexible hose can be installed to aid absorbing the forces created by the natural reciprocating action of the pump. If the pump is to be bolted down to a solid location, a mounting pad placed between the pump and the foundation will assist in minimizing pump vibration. Flexible connections between the pump and rigid piping will also assist in minimizing pump vibration. If quick-closing valves are installed at any point in the discharge system, or if pulsation within a system becomes a problem, a Wilden Equalizer® surge dampener should be installed to protect the pump, piping and gauges from surges and water hammer. Installation of a tee at the discharge of the pump will allow the addition of an Equalizer to the system at a later date without requiring piping modifications. Installation of inlet and discharge isolation valves are also recommended to make service and repair easier.

Pumps in service with a positive suction head are most efficient when pressure is limited to 0.4-0.7 bar (7-10 psig). Premature diaphragm failure may occur if positive suction exceeds these recommended pressures.

A STRAINER SHOULD BE USED ON THE SUCTION LINE OF THE SYSTEM IF THERE IS A POSSIBILITY THAT SOLIDS ENTERING THE PUMP MAY EXCEED THE PUMP'S SOLIDS HANDLING CAPABILITIES.

PLEASE READ AND FOLLOW ALL CAUTIONS NOTED IN THIS MANUAL.

Pump should be thoroughly flushed before installing into process line.

Blow out air line for 10 to 20 seconds before attaching pump to clear all pipe line debris.

Suggested Installation, Operation, Maintenance and Troubleshooting

Operating Principles Behind Accu-Flo™ Pumps

When the solenoid is unpowered, one air chamber is pressurized with air, while the opposite chamber is exhausted. When electric power is applied, the solenoid shifts, and the pressurized air chamber is exhausted while the opposite chamber is pressurized. By alternately applying and removing power, the solenoid-operated pump runs like a standard Wilden pump.

The speed of the pump is controlled electrically. Since each stroke is controlled by an electrical signal, the pump is ideal for batching and other electrically controlled dispensing applications.

Although the speed of the pump is controlled electrically, the air pressure is important. Air pressure displaces the fluid, and if the pressure is insufficient to complete the physical stroke before an electronic impulse signals the pump to shift, the stroke will not be completed, and the displacement per stroke will be reduced. This does not harm the unit in any way, but it may cause inaccuracy when attempting to batch specific quantities with high precision if this effect is not taken into account.

There are three coil voltage options available. One coil allows for 24V DC operation. The second coil option allows for operation with either 12V DC or 24V AC at 60 Hz and the third coil option allows for 110V AC operation.

ELECTRICAL CONNECTIONS

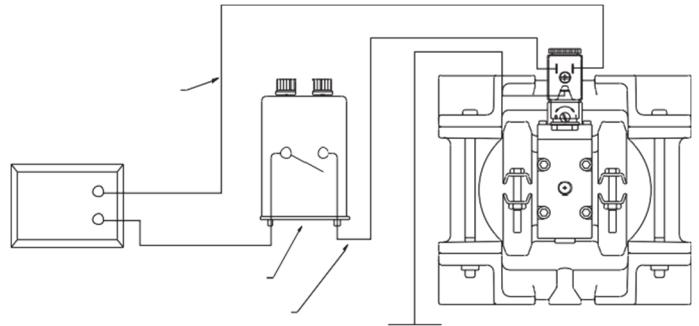

Plumbing Connections

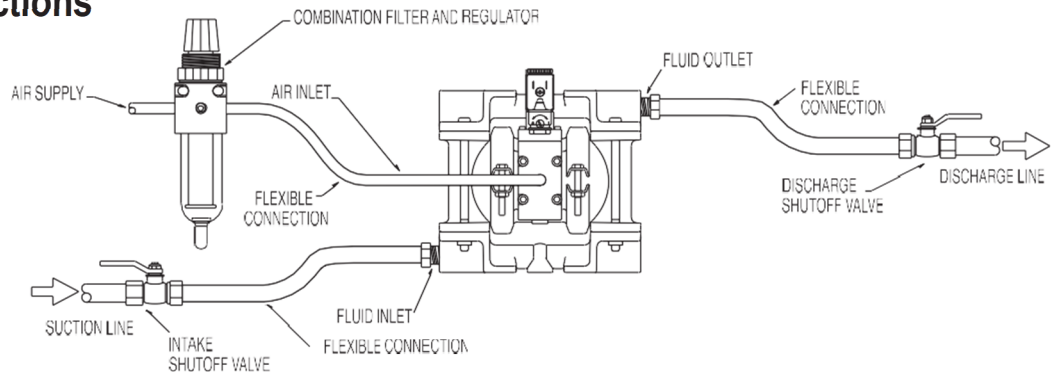

Accu-Flo™ pumps: Accu-Flo™ pumps function with solenoid valves and require an electrical control circuit to supply pulses. Under normal operating conditions, the control circuit is sufficient for starting and stopping the pump. However, the shut off valve (user supplied) installed in the air supply line can be used to stop the pump if necessary. Therefore, it should be located far enough away from the pumping equipment such that it can be reached safely in an emergency situation.



NOTE: In the event of a power failure, the shutoff valve should be closed, if the restarting of the pump is not desirable once power is regained.



NOTE: Wilden 6 mm (1/4") metal pumps come standard side ported with 2 NPT or BSP pipe plugs for side inlet and discharge porting. Center, top and bottom inlet and discharge porting are optional. Simply drill flat areas provided with a 7/16" drill bit for NPT or 11 mm drill bit for BSP and tap with NPT or BSP tap as appropriate.



NOTE: Wilden offers drum pump kits for the Metal P.025/A.025 pump (bung base and pick-up tube) for convenient drum pumping (P/N 50-9290-20/23/55).



NOTE: This pump can be mounted from the underside of a flat surface providing you more flexibility in tight areas/ systems.



CAUTION: Pump performance will be seriously hampered if pump is installed upside down

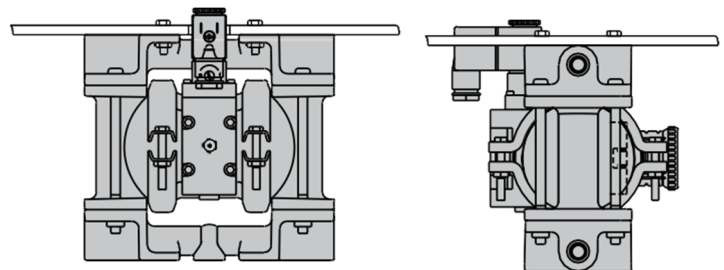

Suggested Installation, Operation, Maintenance and Troubleshooting

Operation

For best results, the pumps should use an air filter and a regulator. The use of an air filter before the pump inlet will ensure that the majority of pipeline contaminants will be eliminated. The solenoid operated pump is permanently lubricated during assembly, and requires no additional lubrication under normal operation. If the unit runs under extreme conditions (continuous operation at high speeds), it may be necessary to relubricate the center block with a Buna-N compatible NLGI Grade 2 grease every 50 million cycles. Continuous lubrication with a compatible oil is not harmful, and will provide longer seal life, but it may flush all grease out of the unit.

The pump will not shift reliably unless the minimum supply pressure is provided. For the A.025T the minimum supply pressure for reliable operation is 2.7 bar (40 psig).

A muffler can be installed to reduce the amount of noise generated by the pump. Use of the specified Wilden muffler will reduce noise levels below OSHA specifications.

Maintenance and Inspections

INSPECTIONS: Periodic inspections have been found to offer the best means for preventing unscheduled pump downtime.

RECORDS: When service is required, a record should be made of all necessary repairs and replacements. Over a period of time, such records can become a valuable tool for predicting and preventing future maintenance problems and unscheduled downtime. In addition, accurate records make it possible to identify pumps that are poorly suited to their applications.

Troubleshooting

Pump will not run.

1. Check for pressurized air at the inlet.
2. Check air inlet and filter for debris.
3. Connect a test lamp to the two wires which run to pump and ensure that the lamp cycles on and off.
4. Make sure that the air valve manual override (small red knob on front of valve) is switched to the "0" position.
5. Check pilot pressure vent at the top of the operator/coil assembly to ensure that it is not clogged.
6. Check for a worn out air valve. If air continually blows out the exhaust in very large quantities, the air valve seals may be worn beyond their ability to function. In this case, the valve must be replaced.
7. NOTE: Before the valve is scrapped, it is possible that it may be saved by completely disassembling the valve, cleaning all components and relubricating the valve.

4. Check for sticking ball check valves. If the material being pumped is not compatible with the pump elastomers, swelling may occur. Replace ball check valves and o-ring with the proper elastomers.
5. Check to make sure that all suction connections are air tight, and that the clamp bands are properly tightened.

Pump rattles.

1. See RBG E9 Troubleshooting Guide.
2. Create false discharge head or suction lift.

Pump air passages blocked with ice.

Check for excessive moisture in compressed air line. As the air expands out the exhaust during the operation of the pump, water vapor entrapped in the compressed air can freeze and block the air passageways in the pump. If this occurs, it may be necessary to install a coalescing filter, an air dryer, or a hot air generator for the compressed air.

Pump runs but little or no fluid comes out.

1. Check that the discharge isolation valve is not closed.
2. Check that the electronic signal is slow enough that the pump is able to complete each physical stroke before it is signaled to change direction. The time required to complete the stroke is determined by a variety of factors which include fluid viscosity and head pressure.
3. Check for pump cavitation; slow pump speed down to match the thickness of the material being pumped.

Air bubbles in pump discharge.

1. Check for diaphragm rupture.
2. Check tightness of piston plates to shaft.

Product comes out of the air exhaust.

1. Check for diaphragm rupture.
2. Check tightness of piston plates to shaft.

Section 7

Disassembly / Reassembly

Pump Disassembly

Tools Required:

- 3/16" Hex key (Allen wrench)
- 3/8" Box Wrench
- 7/16" Wrench or socket for rubber fitted
- 5/16" Wrench
- 3/16" Rod or equivalent
- O-Ring Pick
- Adjustable Wrench
- Vise equipped with soft jaws (such as plywood, plastic or other suitable material)



CAUTION: Before any maintenance or repair is attempted, the compressed air line to the pump should be disconnected and all air pressure allowed to bleed from the pump. Disconnect all intake, discharge, and air lines. Drain the pump by turning it upside down and allowing any fluid to flow into a suitable container. Be aware of any hazardous effects of contact with your process fluid.

The Wilden model A.025 is an air-operated, double-diaphragm pump with all wetted parts of aluminum, stainless steel and Alloy C. The single-piece center section, consisting of center block and air chambers, is molded from polypropylene. All o-rings used in the pump are of special materials and should only be replaced with factory-supplied parts.

PLEASE read all directions before starting disassembly.

The model used for these instructions incorporates rubber diaphragms and PTFE balls. Models with PTFE diaphragms are the same except where noted



NOTE: Replace worn parts with genuine Wilden parts for reliable performance.

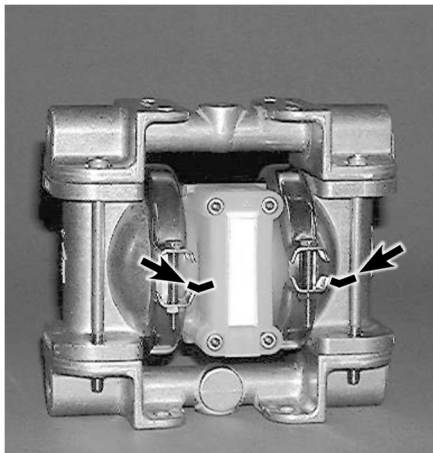

Step 1

Before actual disassembly is started, turn pump upside down and drain all liquid trapped in the pump into a suitable container. Be sure to use proper caution if liquid is corrosive or toxic. Mark each liquid chamber to its respective air chamber for easy alignment during reassembly.

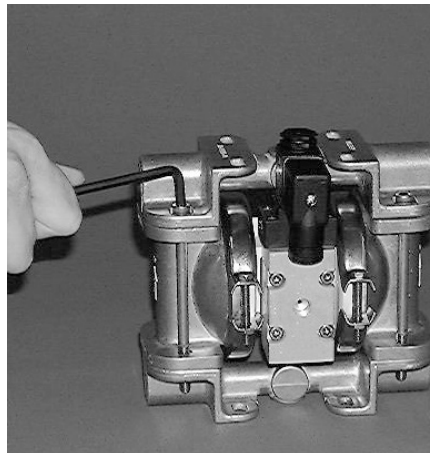

Step 2

Using a 3/16" allen wrench, loosen the four manifold bolts. Remove the top and bottom manifolds.



Step 3

Inspect both manifolds, manifold o-rings, and valve balls. If swelling, cracking or other damage is apparent, these parts must be replaced with genuine Wilden parts.

Disassembly / Reassembly

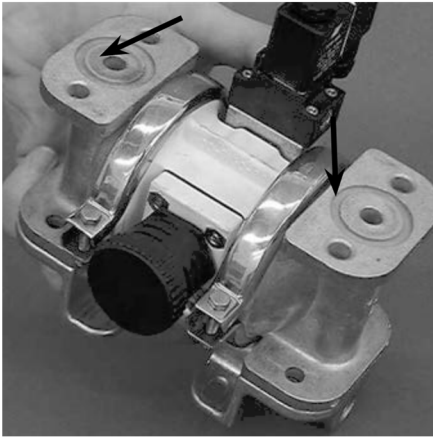

Step 4



NOTE: Top valve seats of Aluminum A.025 pumps are cast in the liquid chamber.

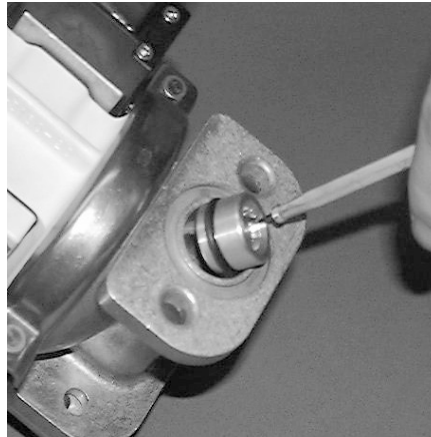

Step 4a

To remove top and bottom valve seats on stainless steel and Alloy C pumps, use an o-ring pick and pull seats out from top to bottom or use 3/16" rod and push seats through.

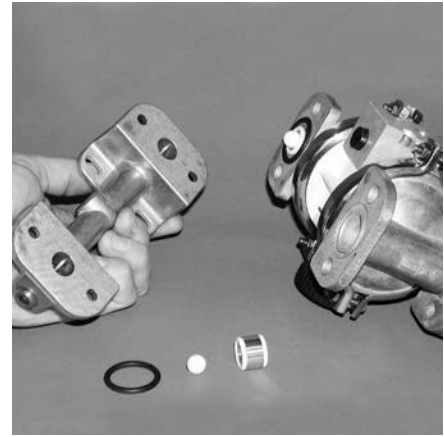

Step 5

Remove bottom manifold. Inspect the valve seat, valve seat o-ring, and valve ball. Check for nicks, gouges, chemical attack or abrasive wear. Replace worn parts with genuine Wilden parts for reliable performance.



NOTE: Aluminum pumps employ 2 o-rings per valve seat.

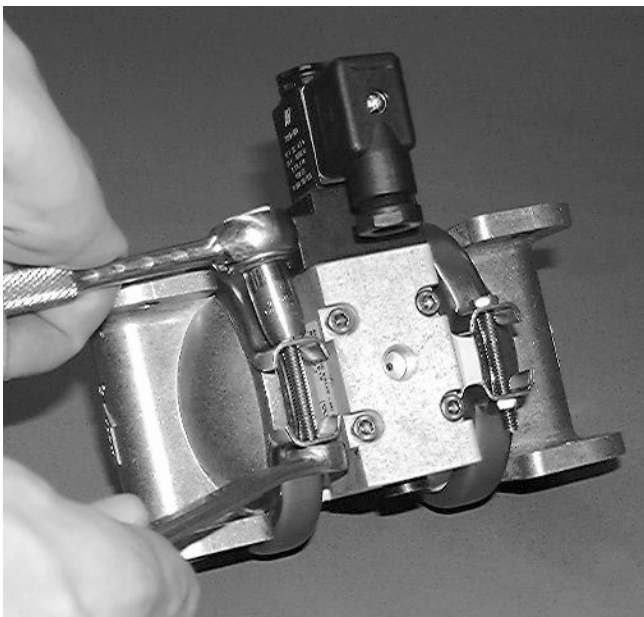

Step 6

Loosen clamp band with 5/16" socket drive and 3/8" wrench. Remove screw and nut.

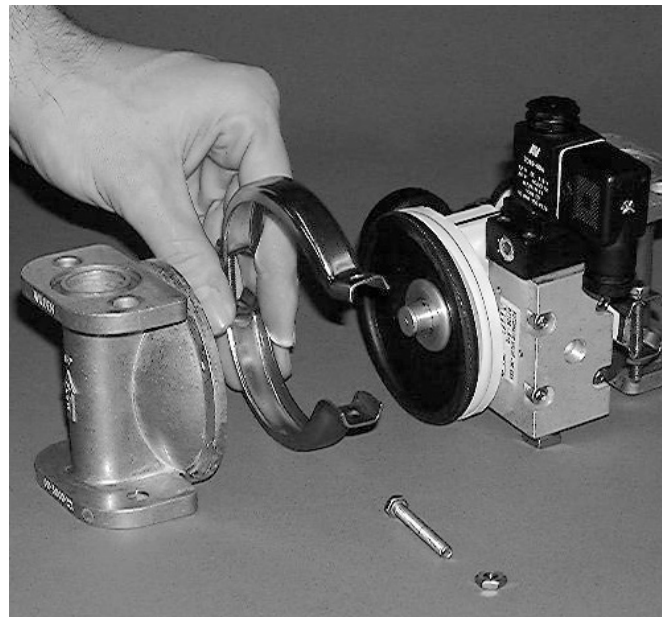

Step 7

After clamp bands are removed, pull chambers away from center section.

Disassembly / Reassembly

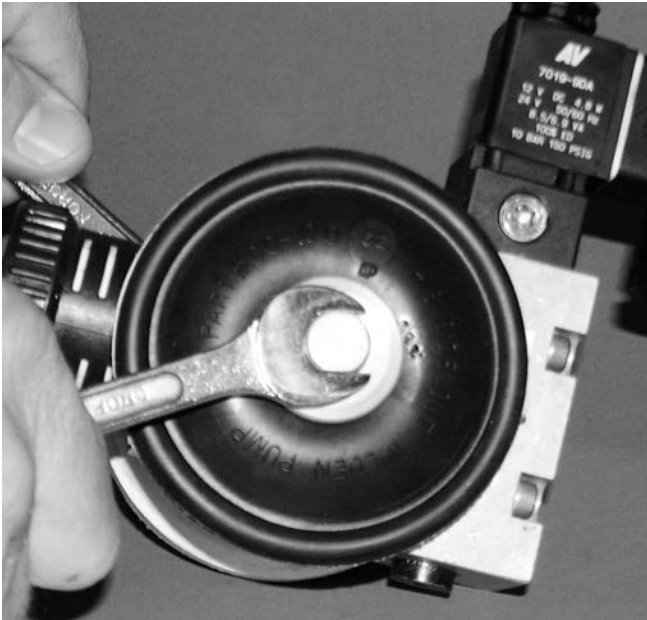

Step 8

Remove outer piston with 7/16" wrench.

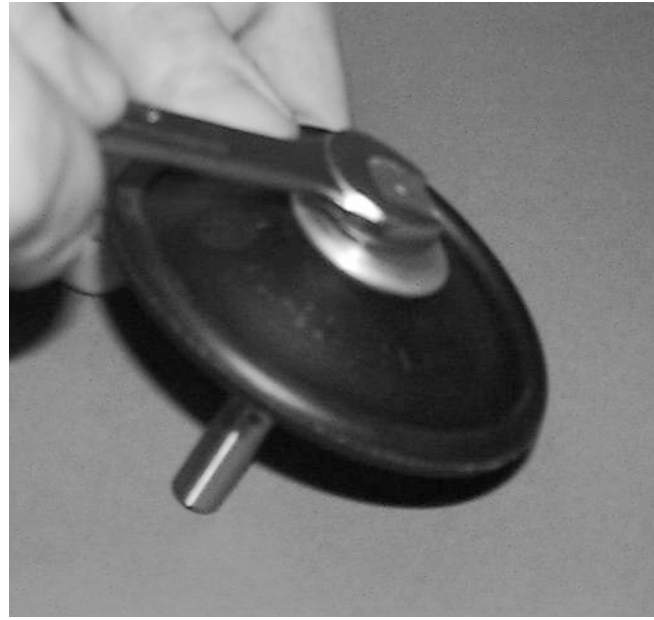

Step 9

Remove shaft and attached outer piston from the center section. Hold the diaphragm and remove outer piston with 7/16" wrench. If unable to remove diaphragm, place shaft in a vise equipped with soft jaws.

⚠ NOTE: See Step 10 for PTFE fitted pumps.



Step 10

For PTFE fitted pumps diaphragms, remove diaphragm by turning in a counter-clockwise direction.

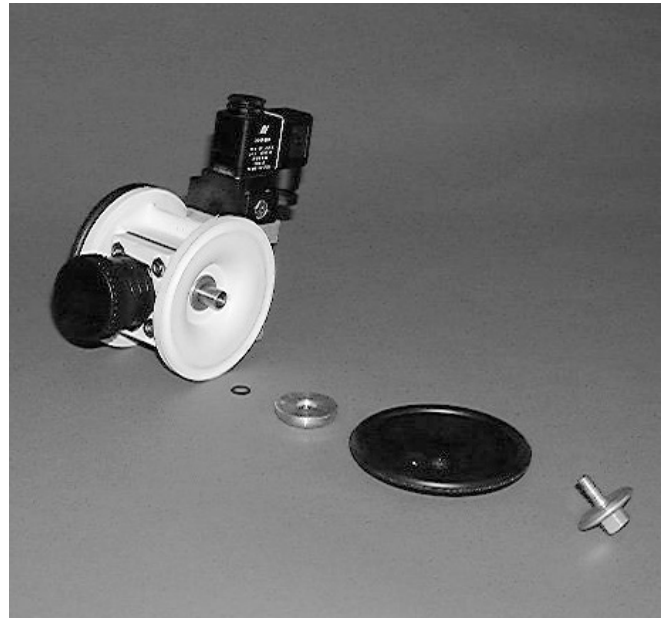

Step 11

Inspection of diaphragms, pistons, disc spring and shaft is now possible.

⚠ NOTE: PTFE fitted pumps utilize a back up o-ring. Inspect all parts for wear and replace with genuine Wilden parts if necessary.

Disassembly / Reassembly

Reassembly Hints & Tips

Upon performing applicable maintenance to the air distribution system, the pump can now be reassembled. Please refer to the disassembly instructions for photos and parts placement. To reassemble the pump, follow the disassembly instructions in reverse order. The air distribution system needs to be assembled first, then the diaphragms and finally the wetted path. Please find the applicable torque specifications on this page. The following tips will assist in the assembly process.

- Clean the inside of the center section shaft bushing to ensure no damage is done to new seals.
- Stainless bolts should be lubed to reduce the possibility of seizing during tightening.
- Apply a small amount of Loctite 242 to the internal threads of the shaft prior to reassembly.

MAXIMUM TORQUE SPECIFICATIONS

Description of Part	Maximum Torque
Air Valve, Solenoid	2.3 N•m (20 in-lbs)
Outer Piston, Rubber and TPE Diaphragms	5.6 N•m (50 in-lbs)
Clamp Band	2.3 N•m (20 in-lbs)
Manifold Bolt	5.75 N•m (50 in-lbs)

Section 8

EXPLODED VIEW AND PARTS LISTING

A.025T METAL

EXPLODED VIEW

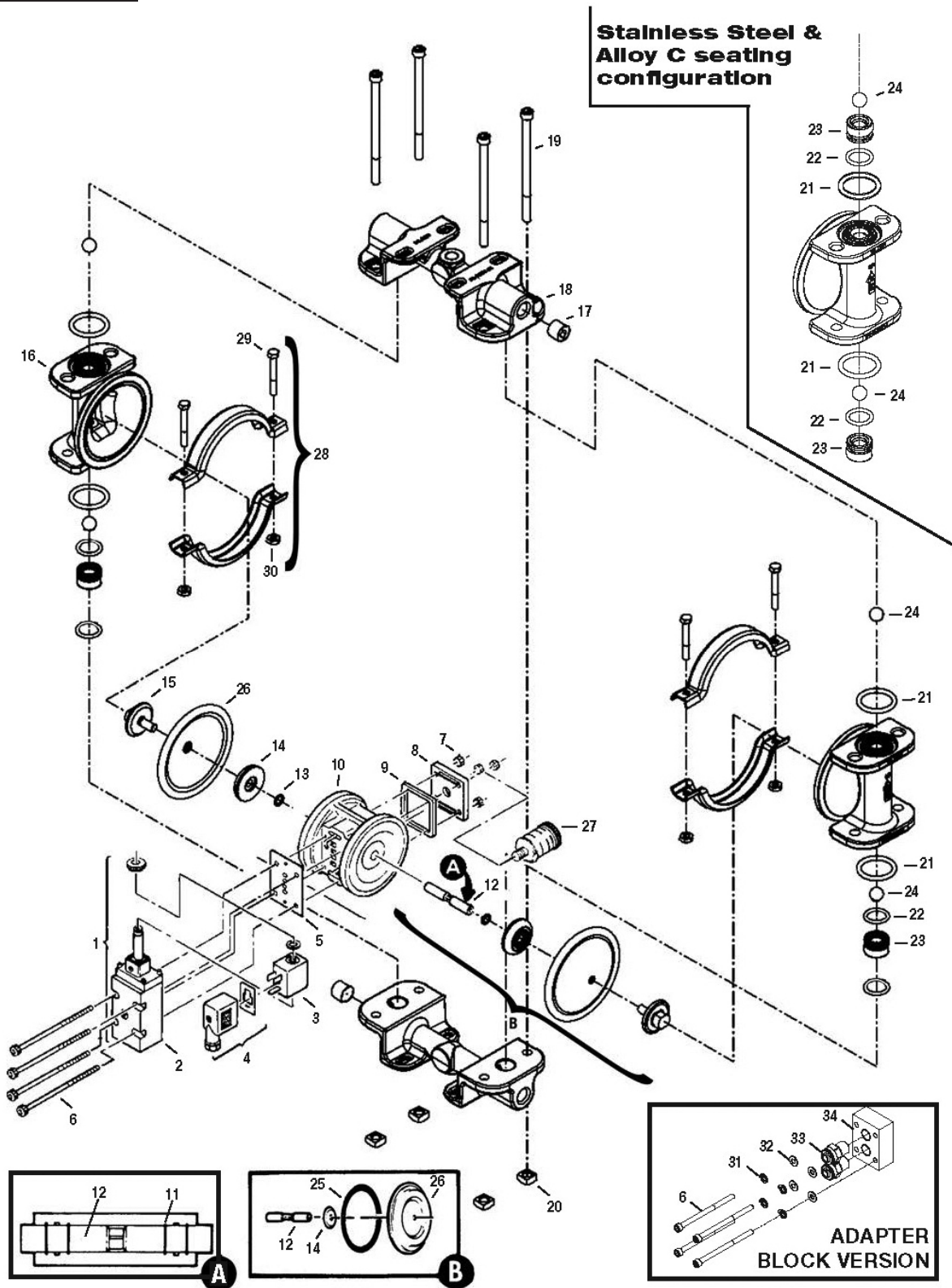

Exploded View and Parts List

Item #	Description	Qty. per Pump	A.025T/AAPPA Aluminum P/N	A.025T/SSPPA Stainless Steel P/N	A.025T/HHPPA Alloy C P/N
1	24 Volt DC Valve Assembly ¹	1	00-2000-99-150	00-2000-99-150	00-2000-99-150
2	Main Valve Body	1	00-2000-01-150	00-2000-01-150	00-2000-01-150
3	24 Volt DC Coil	1	00-2110-99-150	00-2110-99-150	00-2110-99-150
4	Terminal Connector	1	00-2130-99	00-2130-99	00-2130-99
5	Air Valve Gasket-Buna-N	1	00-2600-52	00-2600-52	00-2600-52
6	Air Valve Bolt	4	00-6000-03	00-6000-03	00-6000-03
7	Air Valve Nut	4	01-6400-03	01-6400-03	01-6400-03
8	Muffler Plate	1	00-3180-20	00-3180-20	00-3180-20
9	Muffler Plate Gasket-Buna-N	1	00-3500-52	00-3500-52	00-3500-52
10	Center Section	1	00-3150-20	00-3150-20	00-3150-20
11	Center Block O-Ring	4	00-3200-52	00-3200-52	00-3200-52
12	Shaft	1	00-3800-03	00-3800-03	00-3800-03
13	Disc Spring ²	2	00-6800-08	00-6800-08	00-6800-08
14	Inner Piston for Rubber/TPE	2	00-3700-01-150	00-3700-01-150	00-3700-01-150
	Inner Piston PTFE-fitted	2	00-3750-01-150	00-3750-01-150	00-3750-01-150
15	Outer Piston for Rubber/TPE	2	00-4570-08	00-4570-03	00-4570-04
16	Liquid Chamber	2	00-5000-01	00-5000-03	00-5000-04
17	Pipe Plug (NPT)	2	00-7010-08	00-7010-03	00-7010-04
	Pipe Plug (BSP)	2	00-7011-08	00-7011-03	00-7011-04
18	Manifold (NPT)	2	00-5050-01	00-5050-03	00-5050-04
	Manifold (BSP)	2	00-5051-01	00-5051-03	00-5051-04
19	Manifold Bolt	4	01-6000-03	01-6000-03	01-6000-03
20	Square Nut	4	00-6505-03	00-6505-03	00-6505-03
21	Manifold O-ring*	4	*	*	*
22	Valve Seat O-Ring*	4	*	*	*
23	Valve Seat	4	00-1120-01**	00-1120-03	00-1120-04
24	Valve Ball	4	00-1080-55	00-1080-55	00-1080-55
25	Back-up O-Ring ³	2	00-1070-51	00-1070-51	00-1070-51
26	Diaphragm*	2	*	*	*
27	Muffler	1	00-3510-99	00-3510-99	00-3510-99
28	Clamp Band Assembly	2	00-7300-03	00-7300-03	00-7300-03
29	—Clamp Band Bolt	4	01-6100-03	01-6100-03	01-6100-03
30	—Clamp Band Nut	4	01-6400-03	01-6400-03	01-6400-03
31	Lock Washer ⁴	4	00-6770-03-514	00-6770-03-514	00-6770-03-514
32	Flat Washer ⁴	4	00-6740-03-514	00-6740-03-514	00-6740-03-514
33	Air Fitting ⁴	2	00-2170-20	00-2170-20	00-2170-20
34	Adapter Block ⁴	1	00-2150-XX	00-2150-XX	00-2150-XX

Vent Plug (Not Shown) 00-7020-17-514, Qty 1

* Refer to Elastomer Options in Section 10.

** Quantity per pump is 2.

¹ Air Valve Assembly includes items 1, 2 and 3.

² Part used only on Rubber / TPE-fitted pumps.

³ Part used only on PTFE-fitted pumps.

⁴ Part used on Adapter Block Version

All boldface items are primary wear parts

ADAPTER BLOCK OPTIONS

Material	Part Number
Acetal	00-2150-13
Polypropylene	00-2150-20
UHMW PE	00-2150-32

A.025P METAL

EXPLODED VIEW

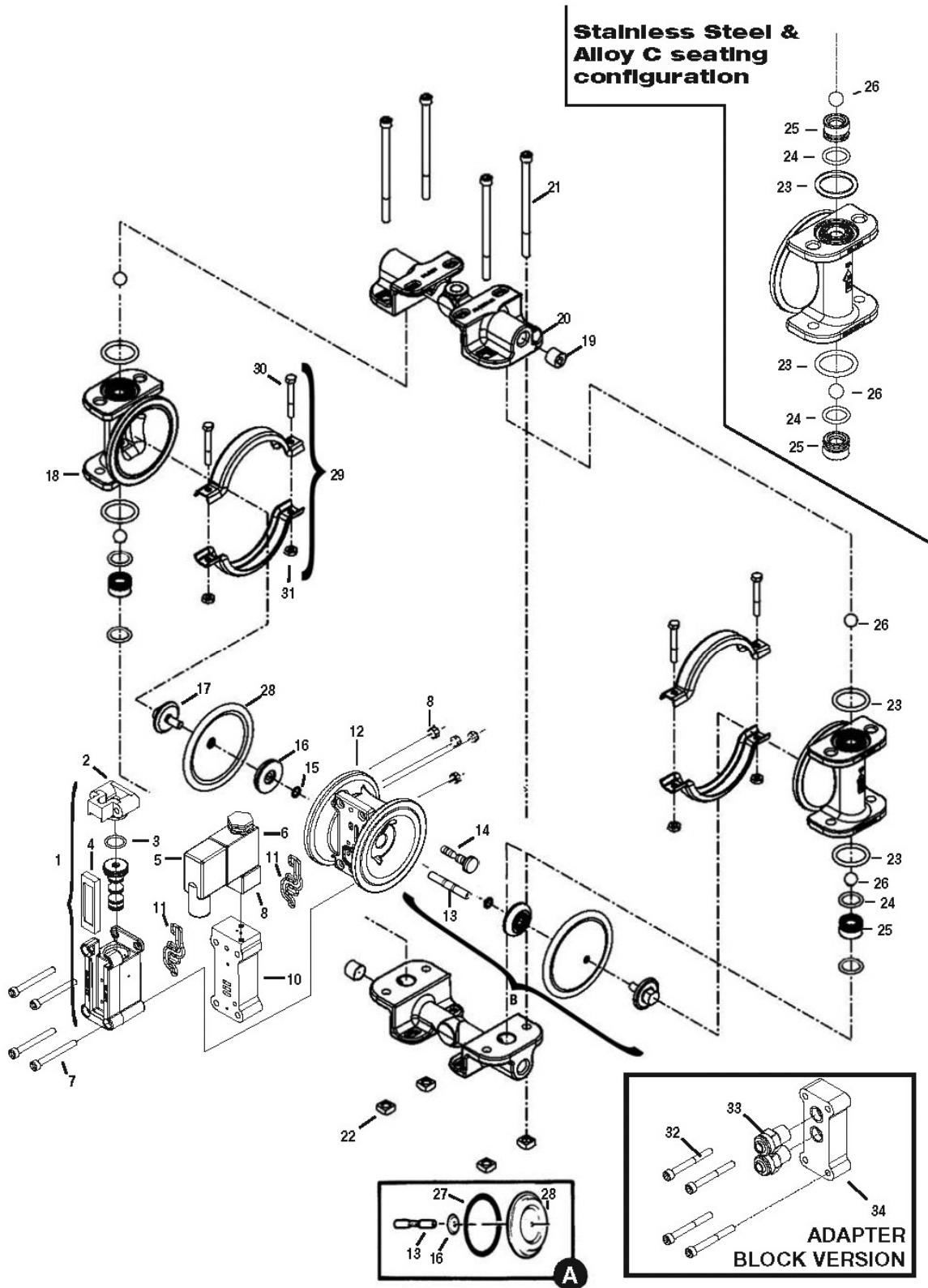

Exploded View and Parts List

Item #	Description	Qty. per Pump	A.025T/AAPPA Aluminum P/N	A.025T/SSPPA Stainless Steel P/N	A.025T/HHPPA Alloy C P/N
1	Pro-Flo® Air Valve Assembly ¹	1	00-2000-20-700	00-2000-20-700	00-2000-20-700
2	Pro-Flo® Air Valve End Cap	1	00-2300-20-700	00-2300-20-700	00-2300-20-700
3	End Cap O-Ring	1	00-2390-52-700	00-2390-52-700	00-2390-52-700
4	Muffler Element	1	00-3240-26-700	00-3240-26-700	00-3240-26-700
5	Terminal Connector ²	1	00-2130-99	00-2130-99	00-2130-99
6	24 Volt DC Coil	1	00-2110-99-150	00-2110-99-150	00-2110-99-150
7	Air Valve Bolt	4	00-6000-03	00-6000-03	00-6000-03
8	Solenoid Operator	1	00-2122-99	00-2122-99	00-2122-99
9	Air Valve Nut	4	01-6400-03	01-6400-03	01-6400-03
10	Pro-Flo® Solenoid Spacer	1	00-2160-20	00-2160-20	00-2160-20
11	Air Valve Gasket	2	00-2600-52-700	00-2600-52-700	00-2600-52-700
12	Center Section	1	00-3150-20-700	00-3150-20-700	00-3150-20-700
13	Shaft	1	00-3800-99-700	00-3800-99-700	00-3800-99-700
14	Pilot Plug Assembly	1	00-2285-99	00-2285-99	00-2285-99
15	Disc Spring ³	2	00-6800-08	00-6800-08	00-6800-08
16	Inner Piston for Rubber/TPE	2	00-3700-01-150	00-3700-01-150	00-3700-01-150
	Inner Piston PTFE-fitted	2	00-3750-01-150	00-3750-01-150	00-3750-01-150
17	Outer Piston for Rubber/TPE	2	00-4570-08	00-4570-03	00-4570-04
18	Liquid Chamber	2	00-5000-01	00-5000-03	00-5000-04
19	Pipe Plug (NPT)	2	00-7010-08	00-7010-03	00-7010-04
	Pipe Plug (BSP)	2	00-7011-08	00-7011-03	00-7011-04
20	Manifold (NPT)	2	00-5050-01	00-5050-03	00-5050-04
	Manifold (BSP)	2	00-5051-01	00-5051-03	00-5051-04
21	Manifold Bolt	4	01-6000-03	01-6000-03	01-6000-03
22	Square Nut	4	00-6505-03	00-6505-03	00-6505-03
23	Manifold O-ring*	4	*	*	*
24	Valve Seat O-Ring*	4	*	*	*
25	Valve Seat	4	00-1120-01**	00-1120-03	00-1120-04
26	Valve Ball	4	00-1080-55	00-1080-55	00-1080-55
27	Back-up O-Ring ⁴	2	00-1070-51	00-1070-51	00-1070-51
28	Diaphragm*	2	*	*	*
29	Clamp Band Assembly	2	00-7300-03	00-7300-03	00-7300-03
30	Clamp Band Bolt	4	01-6100-03	01-6100-03	01-6100-03
31	Clamp Band Nut	4	01-6400-03	01-6400-03	01-6400-03
325	Air Valve Bolt	4	00-6000-03-700	00-6000-03-700	00-6000-03-700
335	Fitting, Air Inlet	2	00-2170-20	00-2170-20	00-2170-20
345	Adapter Block	1	00-2155-20	00-2155-20	00-2155-20

* Refer to Elastomer Options in Section 10.

** Quantity per pump is 2.

¹ Air Valve Assembly includes items 1, 2 and 3.

² Not required for explosion proof model.

³ Part used only on Rubber / TPE-fitted pumps.

⁴ Part used only on PTFE-fitted pumps.

⁵ Parts used on Adapter Block Version.

All boldface items are primary wear parts.

ADAPTER BLOCK & SPACER OPTIONS

Material	Adapter Block	Spacer
Acetal	00-2155-13	00-2160-13
Polypropylene	00-2155-20	00-2160-20

Exploded View and Parts List

Valve Assembly Options (Consists of Valve Body, Coil and Connector)

Pump Models Designating Specialty Code #	Part Number	Description
151	00-2000-99-151	24V AC / 12V DC Valve Assembly
153	00-2000-99-153	24VAC/12VDC Valve Assembly (NEMA 7)*
150	00-2000-99-150	24V DC Valve Assembly
154	00-2000-99-154	24V DC Valve Assembly (NEMA 7)*
155	00-2000-99-155	110V AC Valve Assembly
156	00-2000-99-156	110V AC Valve Assembly (NEMA 7)*
157	00-2000-99-157	International 24 VDC Valve Assembly**

*Not available for A.025P pumps

Item 1 Main Valve Body Options (T-series Center Section)

Part Number	Description
00-2000-01-150	Main Valve Body
00-2000-01-154	Main Valve Body (NEMA 7)

Item 2 Coil Options

Pump Models Designating Specialty Code #	Part Number	Description
150	00-2110-99-150	24V DC Coil
151	00-2110-99-151	24V AC Coil
153	00-2110-99-153	24V AC, NEMA 7 Coil
154	00-2110-99-154	24V DC, NEMA 7 Coil
155	00-2110-99-155	110V AC Coil
156	00-2110-99-156	110V AC NEMA 7 Coil
157	00-2110-99-157	International 24V DC Coil**

** International 24v DC coil is explosion proof per PTB file #EX-91.C. 2027

Section 9

Elastomer Options

A.025 Pumps

Material	Diaphragm	Back-up Diaph. O-ring	Valve Ball	Manifold O-Ring	Valve Seat O-Ring
Wil-Flex™	00-1010-58				00-1200-58 ¹
Buna-N	00-1010-52			04-2390-52	00-1200-52
FKM		00-1070-53			
PTFE	00-1030-55		00-1080-55	00-1370-55	00-1200-55 ¹
PTFE-Encapsulated FKM®					00-1200-60 ¹
Neoprene		00-1070-51			

¹ Wil-Flex and PTFE encapsulated FKM® core valve seat o-rings available on stainless steel and Alloy C only.

Electrical Information

NEMA 4¹ / UL / CSA

Part Number	Voltage ±10%			Power (W) ±10%	Current (A)			Resistivity (Ω)
	DC	AC			DC	AC		
		60 Hz	50 Hz			Inrush	Holding	
00-2110-99-150	24	48	44	4.8	.20	.20	.20	121
00-2110-99-151	12	24	22	4.8	.40	.40	.40	32
00-2110-99-155	60	120	110	4.8	.08	.08	.06	840

NEMA 7 / UL / CSA

Part Number	Voltage ±10%			Power (W) ±10%	Current (A)			Resistivity (Ω)
	DC	AC			DC	AC		
		60 Hz	50 Hz			Inrush	Holding	
00-2110-99-153	12	24	22	7	.60	.55	.32	19
00-2110-99-154	24	48	44	7	.30	.30	.18	75
00-2110-99-156	60	120	110	7	.12	.13	.06	475

INTERNATIONAL EXPLOSION PROOF / CENELEC / PTB FILE # EX-91.C.2027

Part Number	DC Voltage ±10%	Power (W) ±10%	Current (A)		Resistivity (Ω)
			Inrush	Holding	
			00-2110-99-157 ²	24	

¹NEMA 4 and IEC 144/855420 I.P. 66 for "Dust-tight, watertight corrosion resistant."

²Meets European standards and regulations, Cenelec/PTB file # EX-91.C.2027.

Notes

Notes

PSG
22069 Van Buren Street
Grand Terrace, CA 92313-5651 USA
P: +1 (909) 422-1730 • F: +1 (909) 783-3440
psgdover.com



Where Innovation Flows

airpumping.co.uk
est. 1979.  **01708 259870**

PSG® reserves the right to modify the information and illustrations contained in this document without prior notice. This is a non-contractual document. 05- 2018