

# WILDEN®

Expert  
Solutions  
for Critical  
Applications

FIT Bolted Metal  
Brand Portfolio



Where Innovation Flows

[wildenpump.com](http://wildenpump.com)

FIT BOLTED METAL PUMPS

[airpumping.co.uk](http://airpumping.co.uk)

of 1979

Unit 16, Upminster Trading Park, Wainley St, Upminster, Essex, RM14 3PJ, ENGLAND

  
a DOVER company



## Wilden: The Power Behind Fluid Transfer

As the global leader in air-operated double-diaphragm (AODD) pumps, Wilden® has been exceeding customer expectations since 1955 thanks to a deep commitment to the pursuit of excellence, customer satisfaction, research and development and market knowledge.

Wilden and our elite distributor network are devoted to servicing your needs with world-class products, delivery and best-in-class expertise to ensure you have access to the latest pump technologies and fluid transfer services available for your industries, applications and processes.

Put us to the test and contact your local distributor today at: [wildendistributor.com](http://wildendistributor.com)

## MARKETS SERVED

### ENERGY

Wilden is leading the way in energy efficiency in storage terminals, biofuels and solar cell manufacturing. Wilden pumps play a vital role as transfer points from one mode of transportation to another and as safe, secure storage locations until product transfer is needed. Wilden is also committed to helping build a clean-energy economy through the use of biofuels.

#### Typical Applications Handled:

- Raw crude oil
- Biodiesel
- Solar cell manufacturing
- Gasoline
- Chemicals
- Gases
- Petroleum
- Diesel fuel
- Caustics
- Crude oil
- Lube oils
- Refined petroleum products
- Ethanol
- Solvents

### PROCESS

Wilden is a recognized leader in the process industries. You can find Wilden pumps in many of the top chemical, food and beverage and pharmaceutical plants around the world.

#### Typical Applications Handled:

- Acids
- Pulp and paper
- Soap and detergents
- Cosmetics
- Solvents
- Low-solvent coating
- Paints, inks and coatings
- Solvent-less coating
- General chemicals
- Caustics
- Alcohols

### WATER/WASTEWATER

Wilden plays a critical role in handling and transferring fluids used in municipal and industrial water and wastewater plants.

#### Typical Applications Handled:

- Wastewater systems
- Distribution
- Water treatment supply
- Collection and disposal
- Rehabilitation systems
- Metal fabrication
- Potable water systems



## Installation Versatility

### Self Priming

- Portable
- High vacuum
- Run-dry capable
- No heat generation



### Positive Suction Head

- Preferred installation for high-viscosity applications
- Superior product containment
- Inlet pressure should be limited to 0.7 bar (10 psig) to maximize parts life



### Submerged

- Air-operated pumps (non electrical)
- Single-point exhaust options available for submersible applications
- Multiple material options available for process fluid compatibility





## FIT Bolted Metal Pumps

Wilden FIT bolted metal pumps set the standard for air-operated double-diaphragm (AODD) pump performance, providing higher flow rates when compared to many competitors' larger pumps. FIT also provides value by increasing overall performance, efficiency and operational profitability by reducing the cost of ownership.

The best performing AODD pump in the world, FIT is available with either the Pro-Flo® SHIFT, Pro-Flo X™ or Pro-Flo® Air Distribution Systems (ADS). These top-performing air distribution systems increase plant profitability and reduce overall cost of ownership beyond other AODD pumps on the market.

FIT is a direct replacement for most competitor and Wilden pumps in the field, and does not require any repiping for your application. The FIT metal pump has fewer fasteners with single socket assembly technology reducing downtime and making it easy to assemble/disassemble.



## Your Needs



## Our Solutions

### FIT Pumps

- Higher flow rates
- Variable flow and pressure
- Shear sensitive
- Intrinsically safe
- Dry-run capable
- Portable and submersible
- Large solids passage
- High suction lift

### Superior Containment

- Leak-free operation
- Superior torque retention
- Unique valve seat design
- Superior finish on sealing surfaces
- Multiple liquid connections available

### Enhanced Efficiencies

- Anti-freezing ADS
- Greater flow per SCFM input
- Low cost of ownership
- Ease of operation and maintenance

## The Results

### Success

- Higher yields
- Increased pump output
- Increased On/Off reliability
- Reduced turbulence
- Reduced internal friction

### Containment Ensured

- Leak-free pump operation
- Viscous and non-viscous product transfer
- Largest chemical compatibilities
- Transfer with confidence

### Cost Efficient

- Optimized applications
- Reduced air consumption
- Reduced kilowatt usage
- Longest Mean Time Between Repair (MTBR)
- Lower operational costs and downtime
- Saves you money



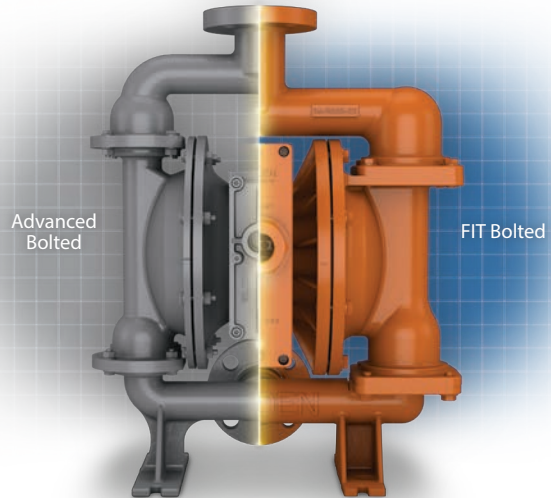
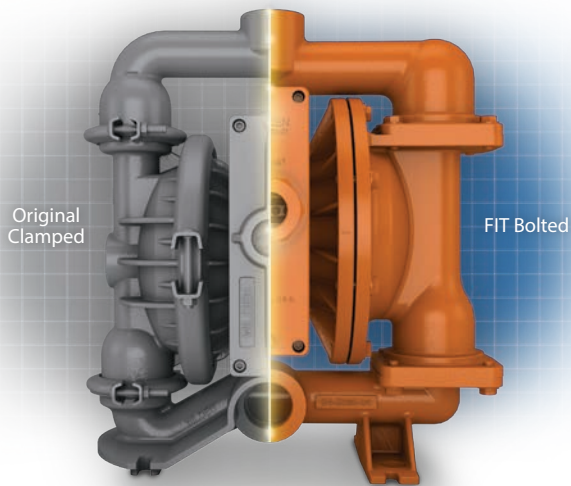

### Wilden Pump Evolution

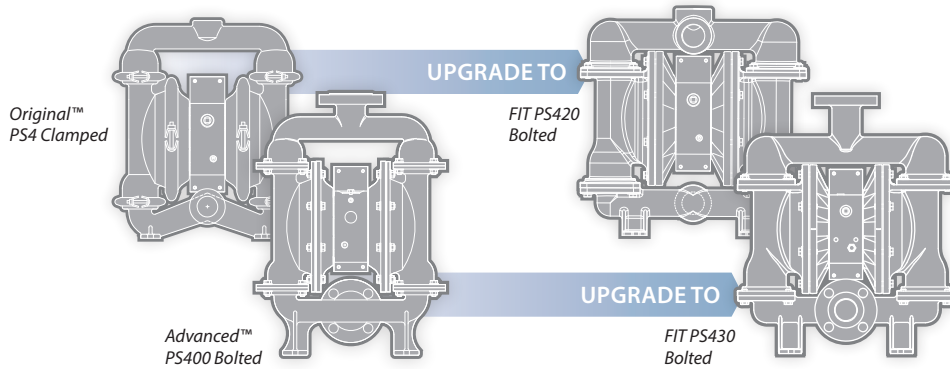

## FIT Bolted Metal Pumps

### Tech Data

- Sizes: 25 mm (1") through 76 mm (3")
- Materials: Aluminum, Ductile Iron, Stainless Steel
- Elastomer Temperatures: Up to 177°C (350°F)
- Elastomers: Buna-N, Neoprene, EPDM, Viton, Wil-Flex™, Saniflex, Polyurethane, PTFE, Geolast
- BSPT (NPT) or DIN (ANSI) liquid connections available
- ADS: Pro-Flo SHIFT, Pro-Flo X, Pro-Flo

### Performance Data

- Max flow rates: 1030 lpm (272 gpm)
- Max suction lift: 9.7 m (31.8') Wet, 7.4 m (24.4') Dry
- Max disp. per stroke: 5.4 L (1.43 gal)
- Max discharge pressure: 8.6 bar (125 psig)
- Max size solids: 12.7 mm (1/2")

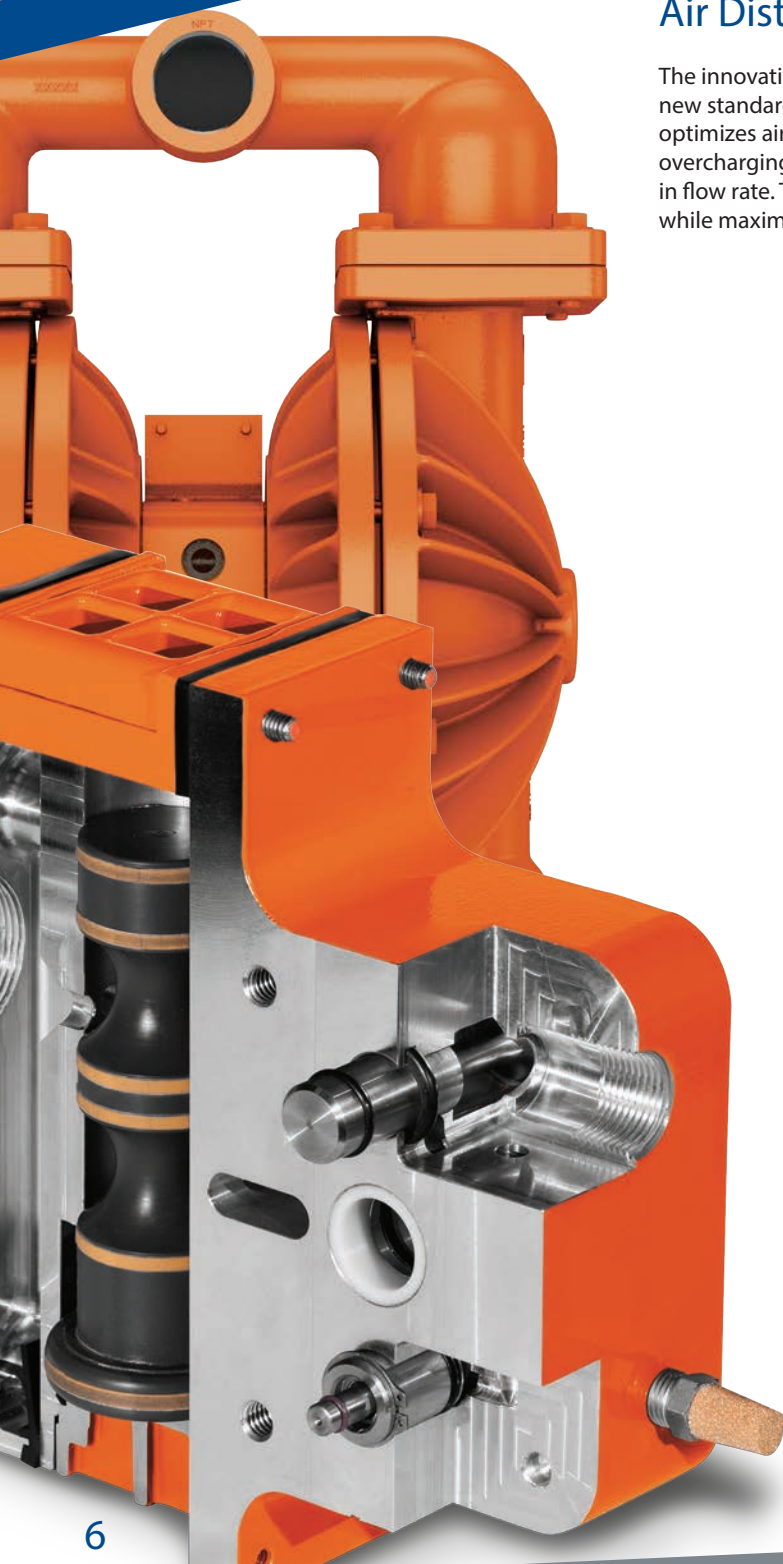

STATE-OF-THE-ART

## Air Distribution Systems

The innovative, yet simple, Pro-Flo® SHIFT Air Distribution System (ADS) is the new standard for AODD pumps, featuring an “air control spool” that automatically optimizes air consumption and eliminates the overfilling that can lead to overcharging of the air chamber, all while causing no corresponding reduction in flow rate. The results are a reduction in air consumption and operational costs while maximum operational efficiency and volumetric consistency are maintained.



### Market Position:

- Cost efficient: 50% less expensive than an electronically-actuated ADS
- Faster return on investment
- Robust design for harsh operating conditions
- Metered air consumption for less product waste
- Creates the highest performance ratio
- Superior flow rate
- Superior anti-freezing
- Single-point exhaust option
- Lube-free operation
- Reduced maintenance costs
- On/Off reliability
- Environmental sensitivity

### Features:

- Simple and durable pump design
- Simple components
- Faster, easier setup time
- Plug-N-Play operation
- No electricity needed
- Precise flow rate at start-up
- Non-stalling unbalanced spool

- Reduced energy consumption
- Lower carbon footprint
- ATEX-compatible for use in explosive atmospheres

### Application Traits:

- Greater yield per SCFM of air used
- Wider application range
- Repeatable, predictable performance
- Less product waste
- Max. Mean Time Between Repair (MTBR)
- Increased application range/compatibility
- Minimum training required
- No special skill set needed for maintenance or operation

### Availability:

- 25 mm (1")
- 38 mm (1-1/2")
- 51 mm (2")
- 76 mm (3")



# SHIFTING PERFORMANCE TO A WHOLE NEW LEVEL.

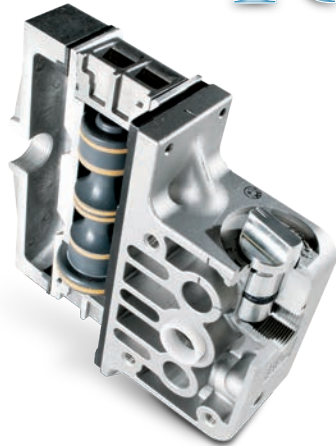

#### Market Position:

- Variable control (discharge flow rates and air consumption)
- Superior flow rate
- Superior anti-freezing
- Single-point exhaust option
- Lube-free operation
- On/Off reliability
- ATEX models available

#### Features:

- Efficiency Management System (EMS™)
- Metal and plastic material options
- Non-stalling unbalanced spool
- Simple and durable design

#### Application Traits:

- Maximize performance and efficiency
- Process applications
- Max. Mean Time Between Repair (MTBR)

#### Availability:

- 38 mm (1-1/2")
- 51 mm (2")
- 76 mm (3")

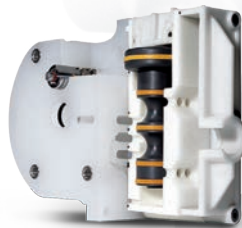

#### Market Position:

- Anti-freezing
- On/Off reliability
- Longest-lasting wear parts
- Lube-free operation

#### Features:

- Plastic center block
- Non-stalling unbalanced spool
- Simple and durable design

#### Application Traits:

- Maximum reliability
- Process applications
- Max. Mean Time Between Repair (MTBR)

#### Availability:

- 38 mm (1-1/2")
- 51 mm (2")





## Progressive Diaphragm Technology

### Thermoplastic Elastomer (TPE)

- Thermoplastic elastomers (TPE) are known for their superior abrasion-resistance and durability. Due to their wide temperature range capabilities and superior flex life, Wilden TPE diaphragms are an excellent option for general purpose applications.
- Wilden TPE elastomer options available include: Polyurethane, Wil-Flex (Santoprene®), Saniflex™ (Hytrel®) and Geolast® (Nitrile Buna-N).
- Also, diaphragm versions of Wil-Flex and Saniflex are available that comply with FDA 21 CFR 177 standards.

### Polytetrafluoroethylene (PTFE) Elastomers

- Because it is one of the most chemically inert compounds available, PTFE can be used with an extremely wide range of fluids, including highly aggressive fluids. Its properties provide excellent flex life and moderate abrasion resistance. In addition, PTFE complies with FDA 21 CFR 177 and USP Class VI standards for food, beverage and pharmaceutical applications. Because PTFE is non-elastic, a backup diaphragm of a different material must be used to provide flexibility and memory. Material options for backup diaphragms are Neoprene, Saniflex, EPDM and high-temperature Buna-N.







## Elastomer Temperature Limits:

<b>Rubber</b>	Neoprene	-18° to 93°C [0° to 200°F]
	Buna-N	-12° to 82°C [10° to 180°F]
	EPDM	-51° to 138°C [-60° to 280°F]
	Viton®	-40 to 177°C [-40 to 350°F]
<b>Thermoplastic (TPE)</b>	Polyurethane	-12° to 66°C [10° to 150°F]
	Wil-Flex	-40° to 107°C [-40° to 225°F]
	Saniflex	-29° to 104°C [-20° to 220°F]
	Geolast	-40° to 82°C [-40° to 180°F]
<b>PTFE</b>	PTFE	4° to 104°C [40° to 220°F]

Teflon®, Hytrel® and Viton® are registered trademarks of DuPont Company  
Geolast® and Santoprene™ are trademarks of ExxonMobil

**CAUTION:** Maximum temperature limits are based upon mechanical stress only. Certain chemicals will significantly reduce maximum safe operating temperatures. Please verify the chemical resistance limitations of elastomers and all other pump components prior to pump installation. The Wilden online Chemical Guide and a Wilden distributor should be consulted for specifics in elastomer selection.

Go to [wildenchemicalguide.com](http://wildenchemicalguide.com) for your Wilden Chemical Compatibility Guide.



### Rubber Elastomers

- Wilden's rubber elastomers are specifically engineered to increase chemical resistance, durability and allow for greater temperature spans, making this a general purpose diaphragm well-suited for a wide range of applications.
- Wilden material options available include: Neoprene, Buna-N, EPDM and Viton®.



### Ultra-Flex™ Diaphragm Technology

- The diaphragm's convolute shape and controlled fabric placement decreases tensile loading to minimize stress concentration. This design reduces internal stress resulting in extremely long diaphragm life.
- Material availability: Neoprene, Buna-N, EPDM, Viton.

Visit [WildenDiaphragms.com](http://WildenDiaphragms.com) for more information on Genuine Wilden Diaphragms and to download the Wilden Chemical Compatibility Guide.

**Genuine WILDEN**  
Accept Nothing Less



## Accessories

Wilden accessory products add value to your liquid process and expand the application range of Wilden pumps by augmenting the performance and/or utility of the pump. Our electronic controllers automate your Wilden pump for batching and other electronically controlled dispensing applications. We can also create laminar process flow by eliminating pump pulsation or control the liquid level within a system of process.

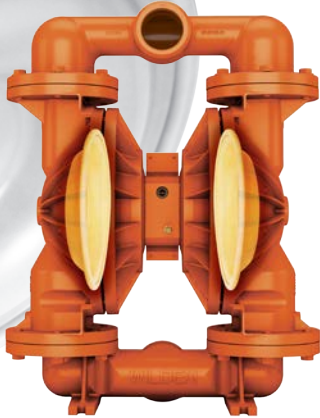

### WILDEN Wil-Gard™ III

The Wil-Gard™ detects diaphragm failure at the source: the primary diaphragm, not at the air chamber or the air exhaust as other systems do.

- Sensors are located between the primary and back-up (containment) diaphragms
- When the sensors detect a conductive liquid, an audible alarm, LED and an internal latching relay are activated
- Increase containment, reduce fugitive emissions and reduce downtime with 24-hour pump surveillance
- Power requirement: 110V AC or 220V AC

### WILDEN Pump Cycle Monitor

The PCMI counts pump cycles by sensing the presence of the air valve piston (Turbo-Flo) or air valve spool (Pro-Flo).

- The sensor, located at the air valve and cap, detects the presence of a magnet located at the end of the air valve piston/spool
- The PCMI registers a complete pump cycle when the piston/spool shifts away from the sensor and subsequently returns to the original position
- The PCMI unit has a reset switch located on the face of the PCMI module
- PCMI has the ability to be reset from a remote location

### WILDEN Drum Pump Kit

The inherent features of the Wilden air-operated pump and Accu-Flo pump technology allow it to excel as a utilitarian drum pump. Variable speed and pressure capability and the ability to run dry, self prime and deadhead offers you flexibility at a low cost. The Wilden universal drum pump kit enables Wilden 1/4" and 1/2" pumps to adapt directly to drums for cost-effective, efficient liquid transfer.

- Universal kit for 6 mm (1/4") and 13 mm (1/2") pumps
- Fits 51 mm (2") NPT bungholes
- Tube length can be cut to length
- Variety of materials are available







## WILDEN SD Equalizer®

The Surge Dampener (SD) Equalizer® was designed to remove pressure variation on the discharge end of the pump. It has a flow-through design manufactured with existing Wilden pump parts. The SD Equalizer automatically sets and maintains the correct air pressure required, optimizing its effectiveness.



### Features and Benefits:

- Reduces pipe vibration and shaking
- Protects in-line equipment
- Reduces water hammer
- Absorbs acceleration head
- Lowers system maintenance cost
- Suction stabilizer
- Helps prevent leaking at pipe fittings and joints
- Extends and improves pump performance
- Avoids damaging pressure surges
- Wide range of material and elastomer options
- Common parts with Wilden pumps
- Self adjusts to system pressure

### Available Sizes:

- 13 mm (1/2")
- 25 mm (1")
- 38 mm (1-1/2")
- 51 mm (2")
- 76 mm (3")

### Materials of Construction:

#### Wetted Housing

- Aluminum
- 316 and 316L Stainless Steel
- Ductile Iron
- Polypropylene
- PVDF

#### Air Distribution System

- Aluminum
- 316 Stainless Steel
- PTFE-Coated Ductile Iron
- Polypropylene
- Glass-filled Polypropylene
- Mild Steel PTFE-Coated

ATEX Models Available





## PS FIT TECHNICAL SPECS

### SIZING CONSIDERATIONS

#### CONNECTION TYPE

PRO-FLO SHIFT  
FIT BOLTED METAL

MODELS	WETTED MATERIALS	LIQUID INLET	LIQUID DISCHARGE	CONNECTION TYPE		SHIPPING WEIGHT
				BSPT/NPT	DIN/ANSI	
PS220	Aluminum Stainless Steel Ductile Iron	25 mm (1")	25 mm (1")	•	-	19 kg (41 lb) 31 kg (68 lb) 29 kg (64 lb)
PS230	Aluminum Stainless Steel Ductile Iron	25 mm (1")	25 mm (1")	-	•	19 kg (41 lb) 31 kg (68 lb) 29 kg (64 lb)
PS420	Aluminum Stainless Steel Ductile Iron	38 mm (1-1/2")	38 mm (1-1/2") H 32 mm (1-1/4") V	•	-	26 kg (57 lb) 50 kg (111 lb) 39 kg (86 lb)
PS430	Aluminum Stainless Steel Ductile Iron	38 mm (1-1/2")	38 mm (1-1/2")	-	•	28 kg (62 lb) 53 kg (116 lb) 42 kg (92 lb)
PS820	Aluminum Stainless Steel Ductile Iron	51 mm (2")	51 mm (2")	•	-	47 kg (104 lb) 73 kg (161 lb) 71 kg (156 lb)
PS830	Aluminum Stainless Steel Ductile Iron	51 mm (2")	51 mm (2")	-	•	54 kg (118 lb) 82 kg (181 lb) 81 kg (178 lb)
PS1520	Aluminum Stainless Steel Ductile Iron	76 mm (3")	76 mm (3")	•	-	69 kg (152 lb) 126 kg (278 lb) 114 kg (151 lb)
PS1530	Aluminum Stainless Steel Ductile Iron	76 mm (3")	76 mm (3")	-	•	101 kg (223 lb) 137 kg (300 lb) 124 kg (272 lb)
HS430S	Stainless Steel	38 mm (1-1/2")	38 mm (1-1/2")	-	•	55 kg (121 lb)

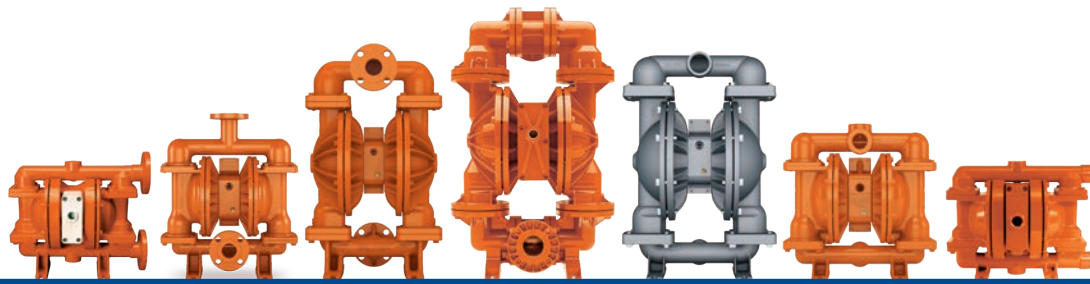

PERFORMANCE

MAX. SUCTION LIFT

MAX. DISCHARGE PRESSURE	MAX. SOLIDS PASSAGE	RUBBER/TPE		PTFE		MAX. FLOW	
		DRY	WET	DRY	WET	RUBBER/TPE	PTFE
8.6 bar (125 psig)	6.4 mm (1/4")	6.9 m (22.7')	9.0 m (29.5')	5.2 m (17.0')	9.0 m (29.5')	254 lpm (56 gpm)	238 lpm (52 gpm)
8.6 bar (125 psig)	6.4 mm (1/4")	6.9 m (22.7')	9.0 m (29.5')	5.2 m (17.0')	9.0 m (29.5')	254 lpm (56 gpm)	238 lpm (52 gpm)
8.6 bar (125 psig)	6.4 mm (1/4")	5.9 m (19.5')	9.6 m (30.6')	5.2 m (17.0')	9.0 m (29.5')	510 lpm (135 gpm)	485 lpm (128 gpm)
8.6 bar (125 psig)	6.4 mm (1/4")	6.2 m (20.4')	9.3 m (30.6')	5.5 m (17.9')	9.3 m (30.6')	510 lpm (135 gpm)	485 lpm (128 gpm)
8.6 bar (125 psig)	6.4 mm (1/4")	7.1 m (23.3')	9.0 m (29.5')	6.6 m (21.8')	9.0 m (29.5')	685 lpm (181 gpm)	678 lpm (179 gpm)
8.6 bar (125 psig)	6.4 mm (1/4")	7.1 m (23.3')	9.0 m (29.5')	6.6 m (21.8')	9.0 m (29.5')	685 lpm (181 gpm)	678 lpm (179 gpm)
8.6 bar (125 psig)	12.7 mm (1/2")	7.2 m (23.8')	9.7 m (31.8')	6.2 m (20.2')	9.7 m (31.8')	1026 lpm (271 gpm)	992 lpm (262 gpm)
8.6 bar (125 psig)	12.7 mm (1/2")	7.2 m (23.8')	9.7 m (31.8')	6.2 m (20.2')	9.7 m (31.8')	1026 lpm (271 gpm)	992 lpm (262 gpm)
17.2 bar (250 psig)	6.4 mm (1/4")	2.0 m (6.8')	9.0 m (29.5')	-	-	264 lpm (70 gpm)	-

PRO-FLO SHIFT  
FIT BOLTED METAL

## PX FIT TECHNICAL SPECS

### SIZING CONSIDERATIONS

### CONNECTION TYPE

### PRO-FLO X FIT BOLTED METAL

MODELS	WETTED MATERIALS	LIQUID INLET	LIQUID DISCHARGE	CONNECTION TYPE		SHIPPING WEIGHT
				BSPT/NPT	DIN/ANSI	
PX420	Aluminum Stainless Steel	38 mm (1-1/2")	38 mm (1-1/2") H 32 mm (1-1/4") V	•	-	26 kg (57 lb) 50 kg (111 lb)
PX430	Aluminum Stainless Steel	38 mm (1-1/2")	38 mm (1-1/2")	-	•	28 kg (62 lb) 53 kg (116 lb)
PX820	Aluminum Stainless Steel	51 mm (2")	51 mm (2")	•	-	47 kg (104 lb) 73 kg (161 lb)
PX830	Aluminum Stainless Steel	51 mm (2")	51 mm (2")	-	•	54 kg (118 lb) 81 kg (178 lb)
PX1520	Aluminum Stainless Steel	76 mm (3")	76 mm (3")	•	-	70 kg (152 lb) 126 kg (278 lb)
PX1530	Stainless Steel	76 mm (3")	76 mm (3")	-	•	137 kg (300 lb)



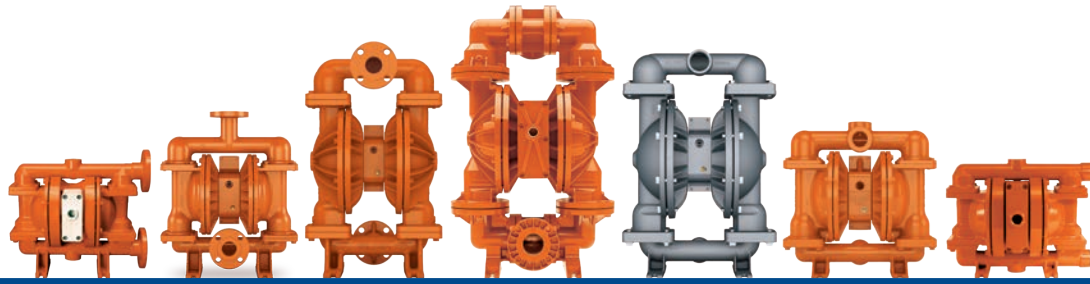

**PERFORMANCE**

**MAX. SUCTION LIFT**

**RUBBER/TPE**

**PTFE**

**MAX. FLOW**

**MAX. DISCHARGE PRESSURE**

**MAX. SOLIDS PASSAGE**

**DRY**

**WET**

**DRY**

**WET**

**RUBBER/TPE**

**PTFE**

8.6 bar  
(125 psig)

6.4 mm (1/4")

5.9 m  
(19.5')

9.3 m  
(30.6')

5.9 m  
(19.5')

9.3 m  
(30.6')

507 lpm  
(134 gpm)

499 lpm  
(132 gpm)

8.6 bar  
(125 psig)

6.4 mm (1/4")

5.9 m  
(19.5')

9.3 m  
(30.6')

5.9 m  
(19.5')

9.3 m  
(30.6')

507 lpm  
(134 gpm)

499 lpm  
(132 gpm)

8.6 bar  
(125 psig)

6.4 mm (1/4")

6.9 m  
(22.7')

9.0 m  
(29.5')

6.6 m  
(21.6')

9.0 m  
(29.5')

712 lpm  
(188 gpm)

653 lpm  
(172 gpm)

8.6 bar  
(125 psig)

6.4 mm (1/4")

6.9 m  
(22.7')

9.0 m  
(29.5')

6.6 m  
(21.6')

9.0 m  
(29.5')

712 lpm  
(188 gpm)

653 lpm  
(172 gpm)

8.6 bar  
(125 psig)

12.7 mm (1/2")

6.6 m  
(21.7')

9.2 m  
(30.1')

6.4 m  
(21.0')

9.3 m  
(30.6')

1030 lpm  
(272 gpm)

985 lpm  
(260 gpm)

8.6 bar  
(125 psig)

12.7 mm (1/2")

6.2 m  
(20.4')

9.2 m  
(30.1')

6.1 m  
(19.9')

9.3 m  
(30.6')

1030 lpm  
(272 gpm)

985 lpm  
(260 gpm)

**PRO-FLO X  
FIT BOLTED METAL**

# P FIT TECHNICAL SPECS

## SIZING CONSIDERATIONS

### CONNECTION TYPE

#### PRO-FLO FIT BOLTED METAL

MODELS	WETTED MATERIALS	LIQUID INLET	LIQUID DISCHARGE	CONNECTION TYPE		SHIPPING WEIGHT
				BSPT/NPT	DIN/ANSI	
P420	Aluminum Stainless Steel Ductile Iron	38 mm (1-1/2")	38 mm (1-1/2") H 32 mm (1-1/4") V	•	-	26 kg (57 lb) 50 kg (111 lb) 39 kg (86 lb)
P430	Aluminum Stainless Steel Ductile Iron	38 mm (1-1/2")	38 mm (1-1/2")	-	•	28 kg (57 lb) 53 kg (116 lb) 42 kg (92 lb)
P820	Aluminum Stainless Steel Ductile Iron	51 mm (2")	51 mm (2")	•	-	47 kg (104 lb) 73 kg (161 lb) 71 kg (156 lb)
P830	Aluminum Stainless Steel Ductile Iron	51 mm (2")	51 mm (2")	-	•	54 kg (118 lb) 81 kg (178 lb) 82 kg (181 lb)

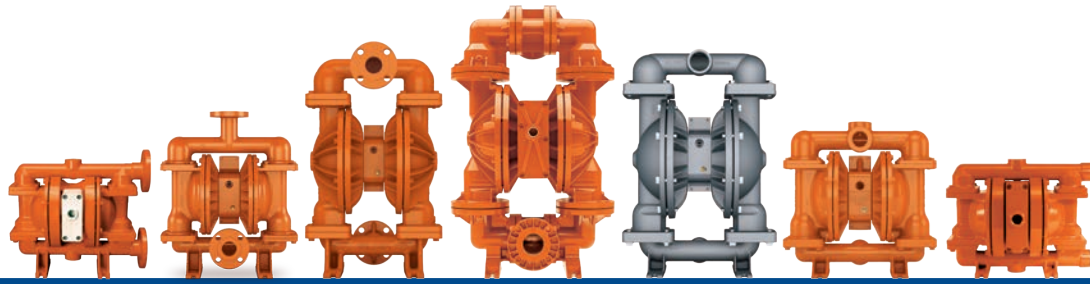

**PERFORMANCE**

**MAX. SUCTION LIFT**

MAX. DISCHARGE PRESSURE	MAX. SOLIDS PASSAGE	RUBBER/TPE		PTFE		MAX. FLOW	
		DRY	WET	DRY	WET	RUBBER/TPE	PTFE
8.6 bar (125 psig)	6.4 mm (1/4")	5.5 m (18.2')	9.0 m (29.5')	5.2 m (17.0')	9.0 m (29.5')	492 lpm (130 gpm)	473 lpm (125 gpm)
8.6 bar (125 psig)	6.4 mm (1/4")	5.5 m (18.2')	9.0 m (29.5')	5.2 m (17.0')	9.0 m (29.5')	492 lpm (130 gpm)	473 lpm (125 gpm)
8.6 bar (125 psig)	6.4 mm (1/4")	7.4 m (24.3')	9.0 m (29.5')	6.9 m (22.6')	9.0 m (29.5')	609 lpm (161 gpm)	590 lpm (156 gpm)
8.6 bar (125 psig)	6.4 mm (1/4")	7.4 m (24.3')	9.0 m (29.5')	6.9 m (22.6')	9.0 m (29.5')	609 lpm (161 gpm)	590 lpm (156 gpm)

**PRO-FLO FIT BOLTED METAL**



# PERFORMANCE CURVES

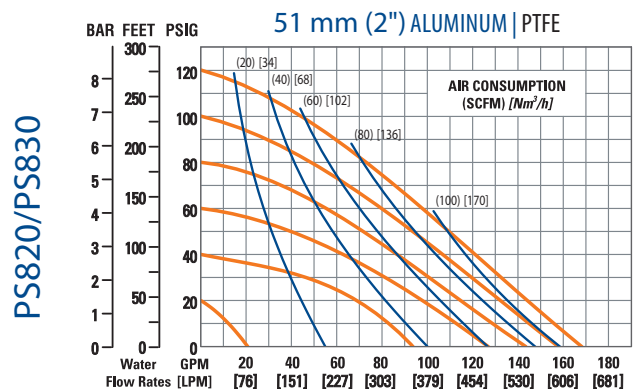
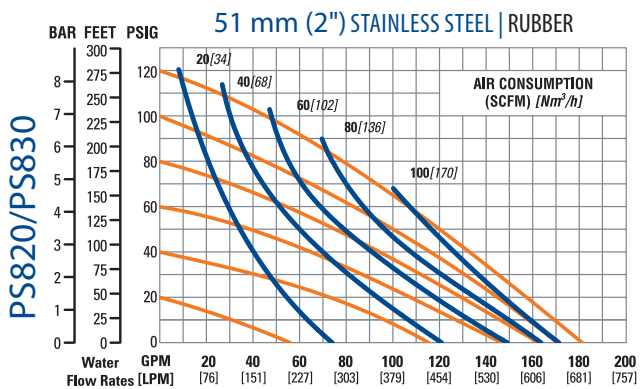
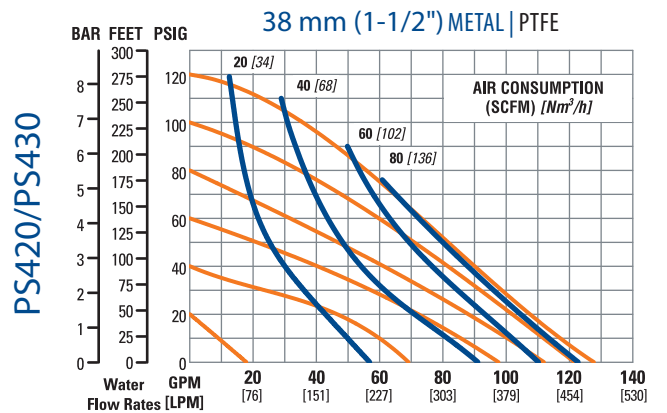
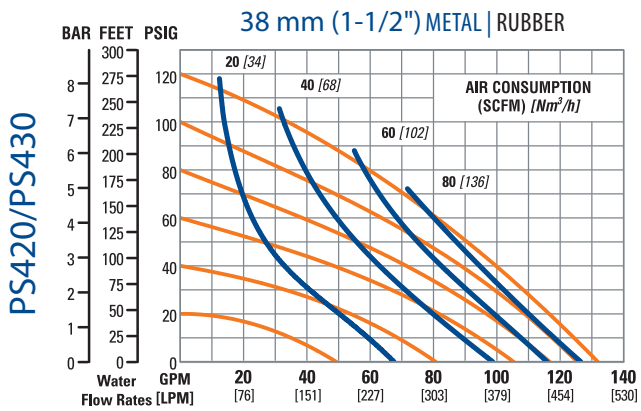
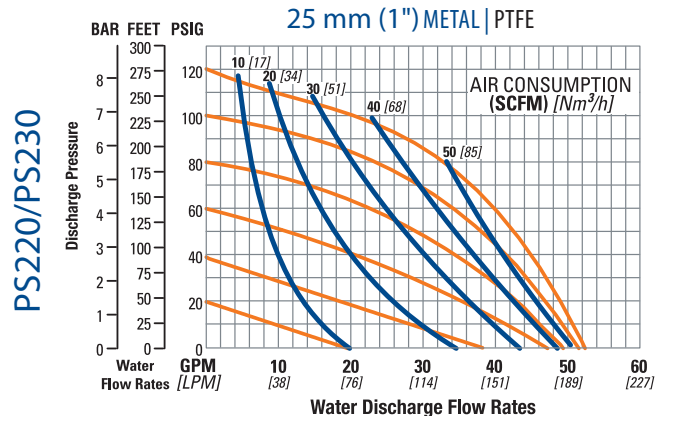
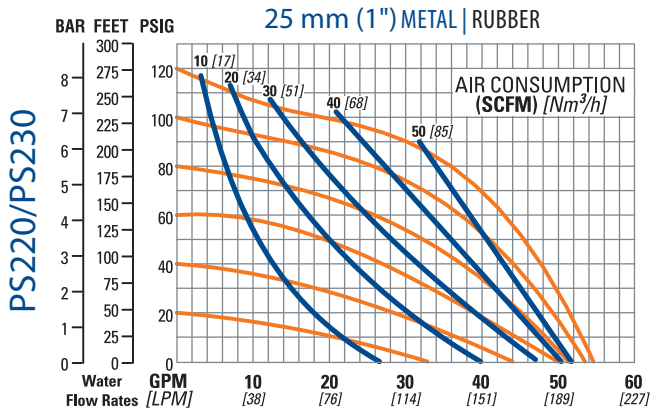

# PERFORMANCE CURVES

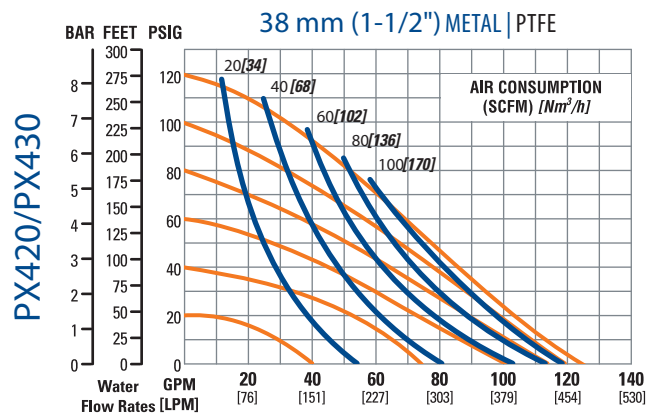
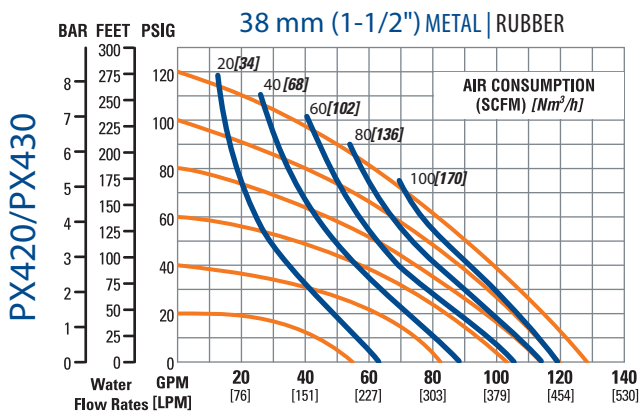
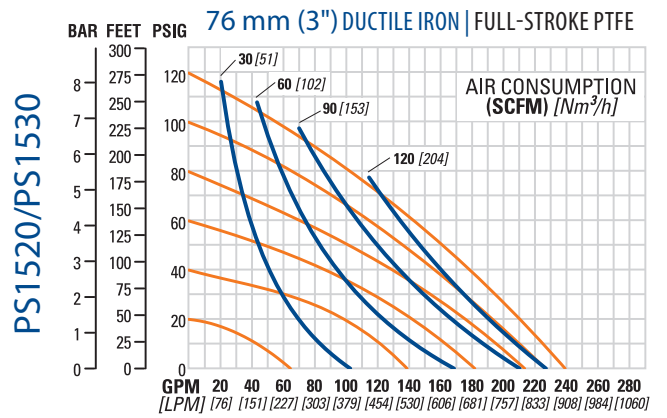
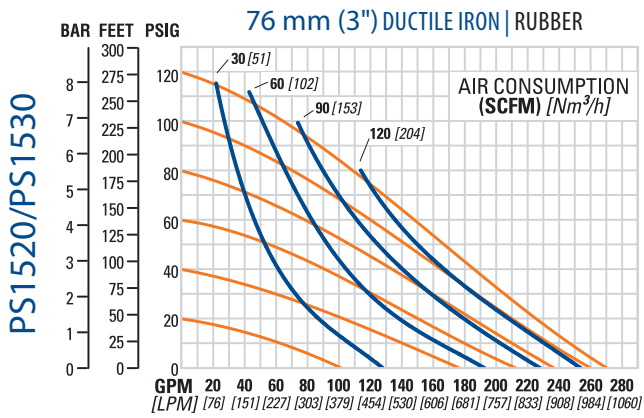
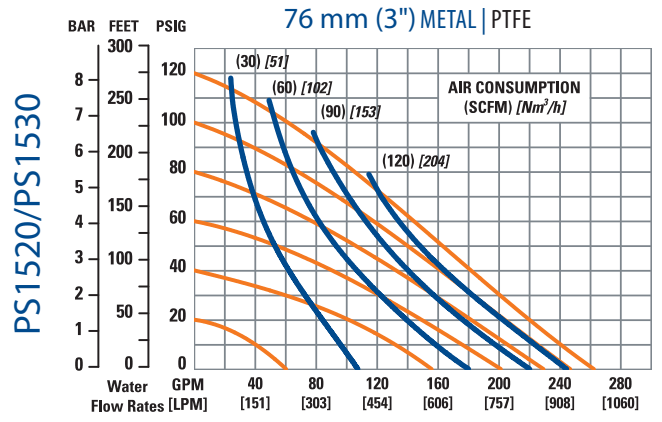
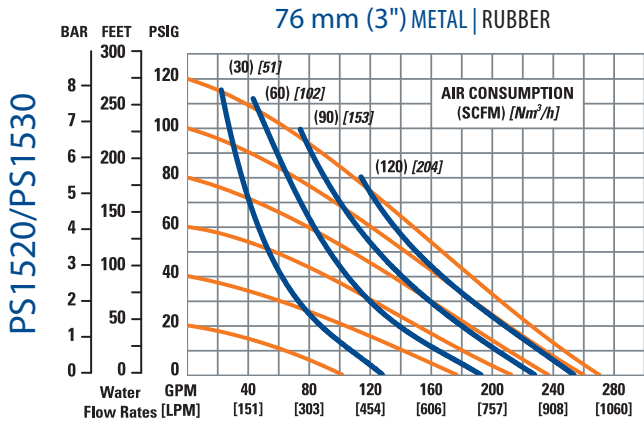

# PERFORMANCE CURVES

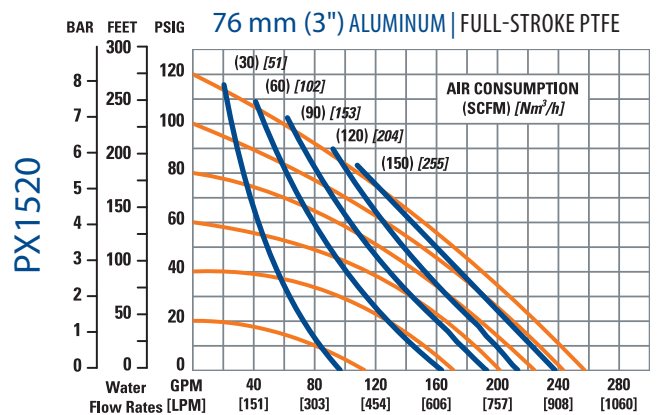
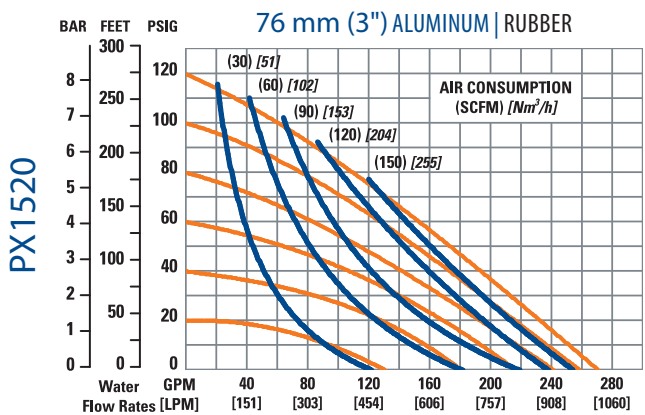
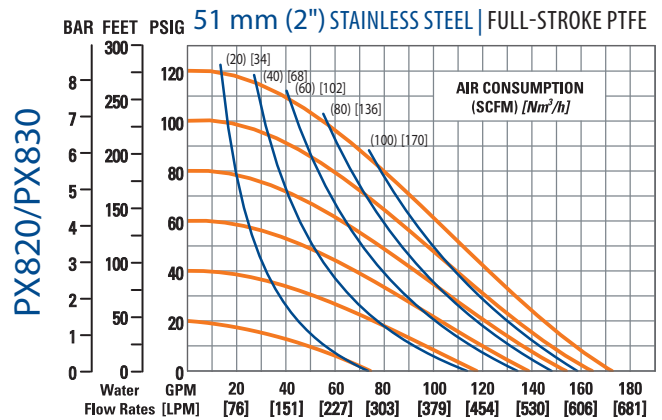
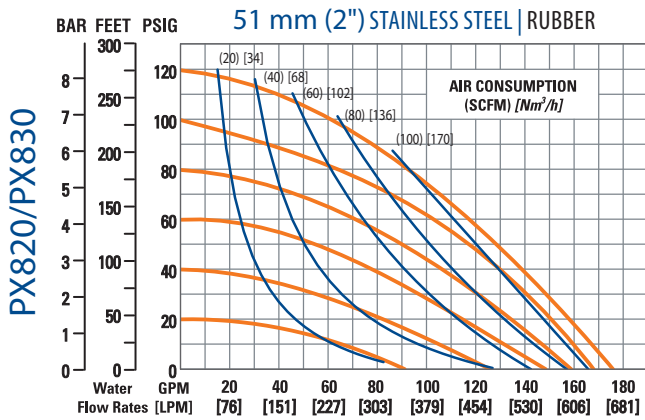
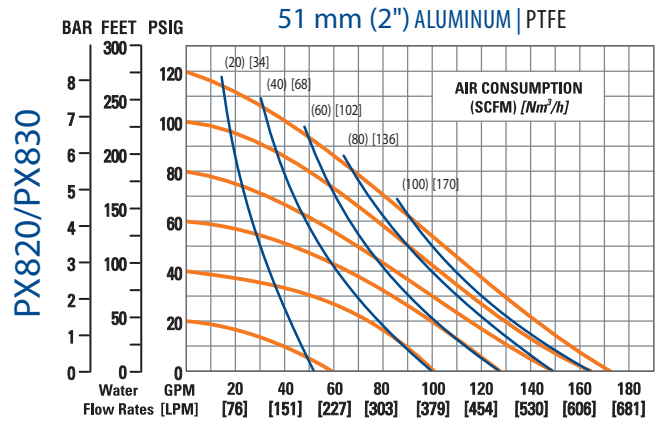
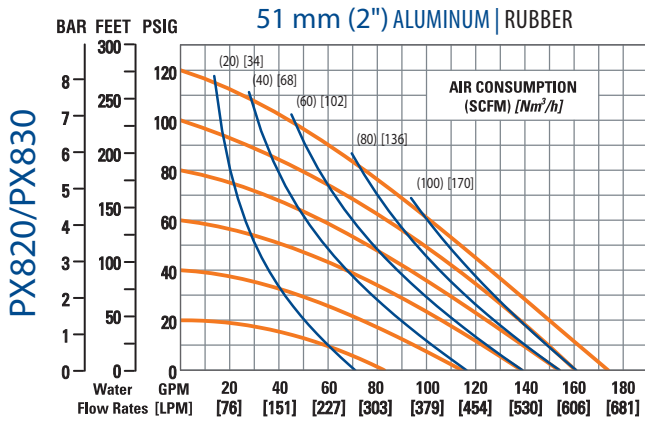



# PERFORMANCE CURVES

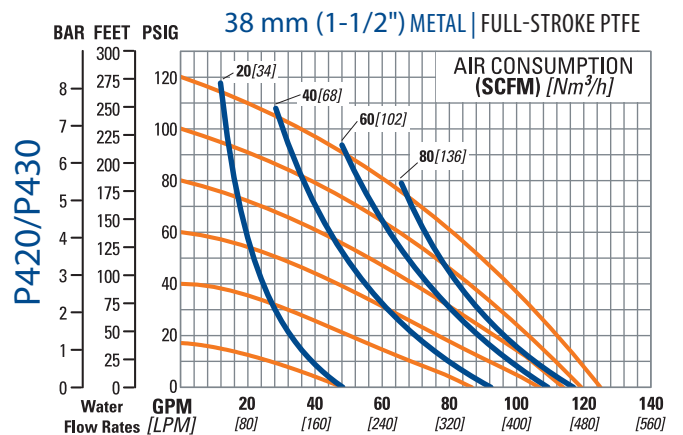
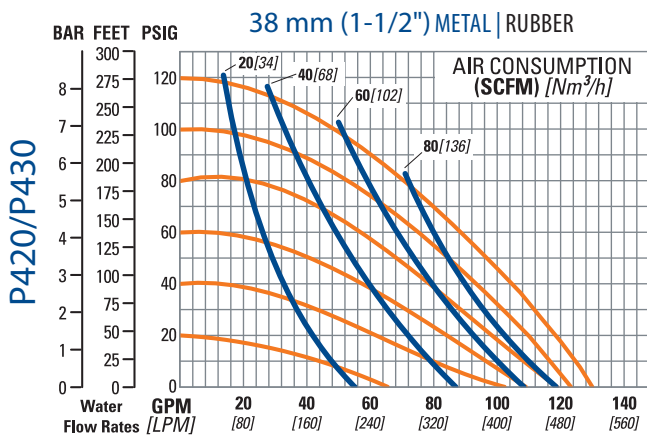
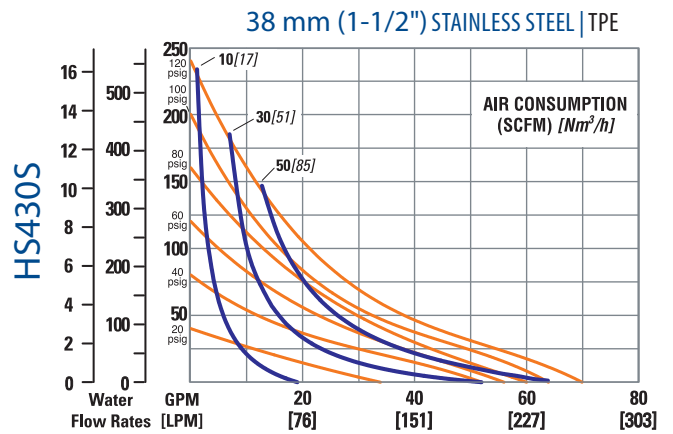
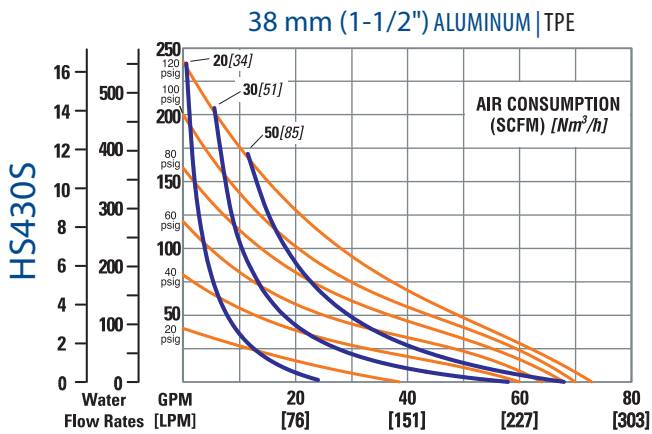
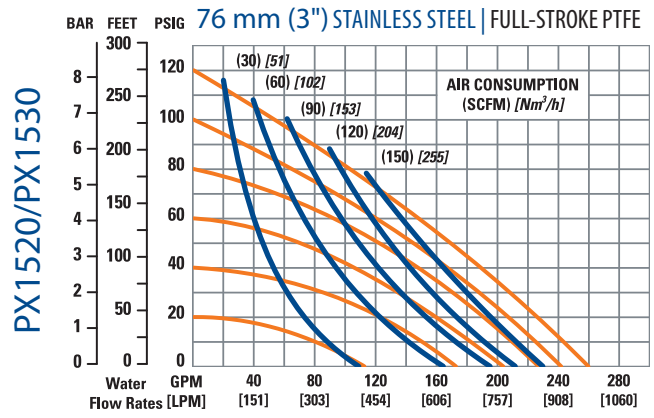
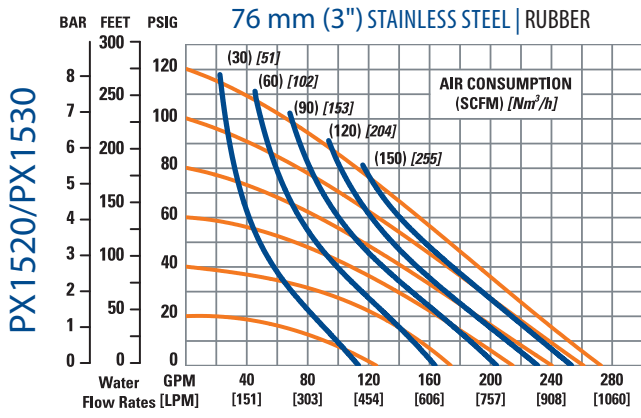

## PERFORMANCE CURVES

51 mm (2") METAL | RUBBER

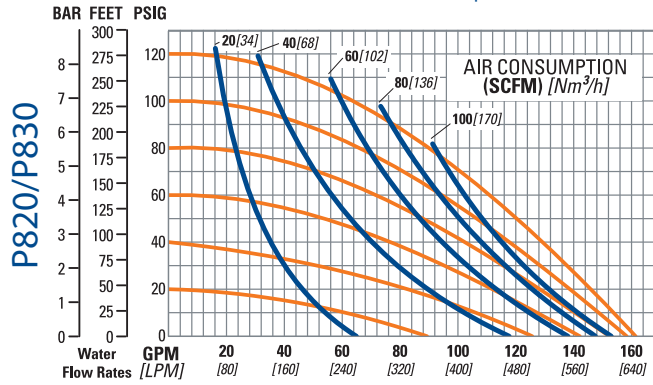

51 mm (2") METAL | FULL-STROKE PTFE

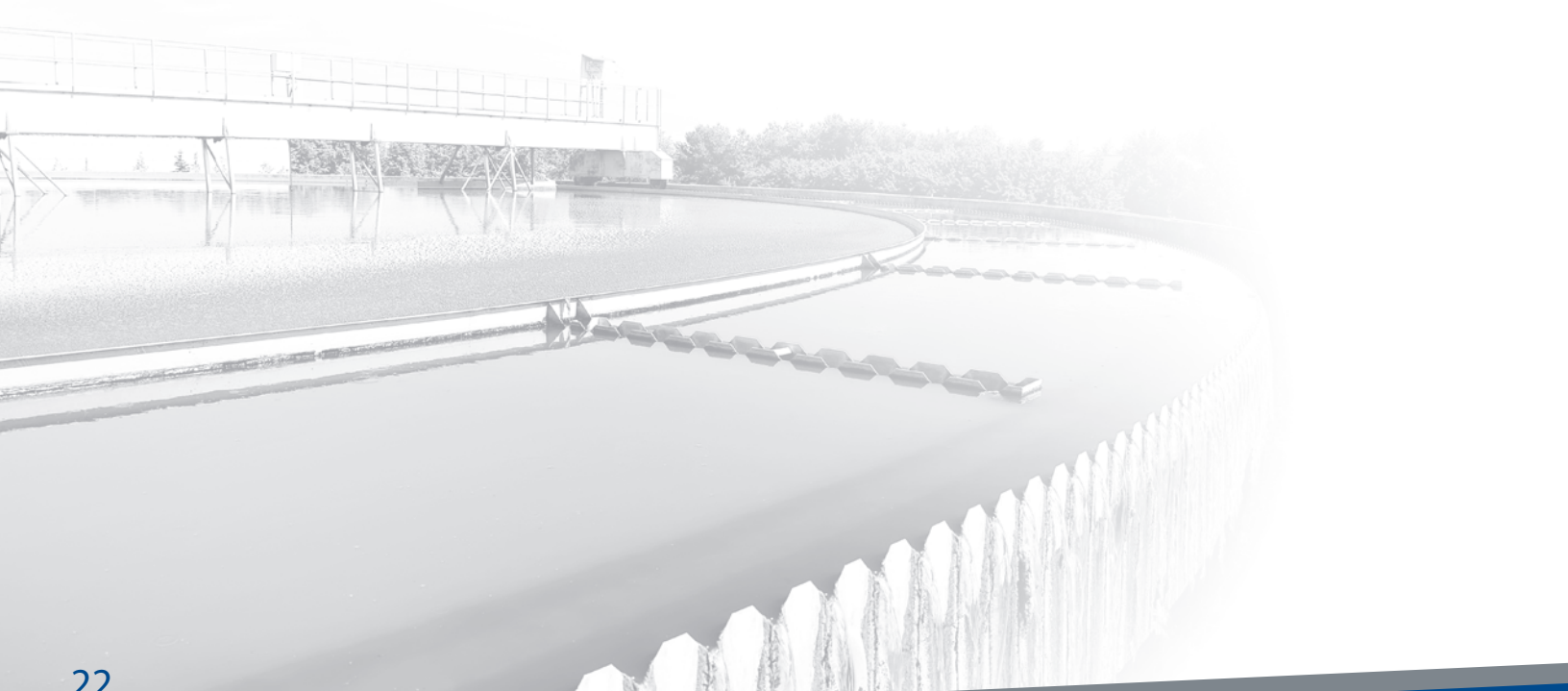
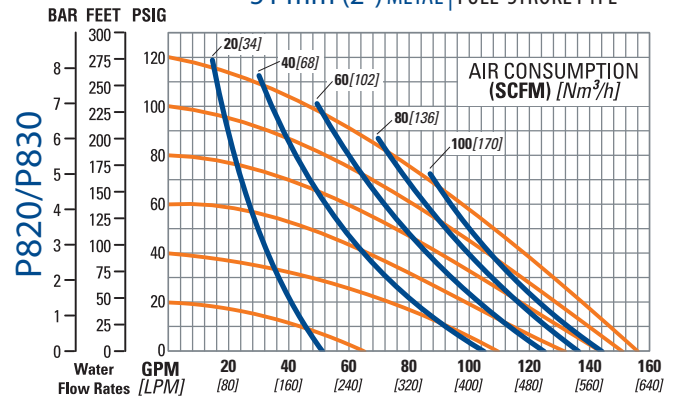

# Things to Think About

When Selecting an Air-Operated Double-Diaphragm (AODD) Pump

## Application

- What application will the pump be used in?
- What are you pumping?
- Do you need lube-free operation?
- Does the pump need to be submersible?
- What cleaning fluids would be used to clean the pump?
- What are your performance parameters (flow rates, air consumption, viscosities, suction lift)?
- Do you need a pulsation dampener?

## Air Distribution System (ADS)

- What ADS best suits your application needs?
- How reliable is the ADS?
- How efficient is the ADS?
- Do you need On/Off reliability?
- Is the pump ADS ATEX-approved?
- Does the ADS have anti-freezing technology?
- Does the ADS have integrated variable performance controls?

## Installation

- Before installation please read the caution section of the pump manual.
- What are your piping considerations (valves, elbows, pipe friction losses, etc.)?
- Do you have sufficient air pressure and air volume for the pump?
- What is the MTBR (Mean Time Between Repair) of the AODDP?
- What are your installation parameters (self priming, positive suction head, high vacuum, heat generation, dry run capable, submersible, large solids passage, variable flow and pressure, shear sensitive)?
- Ease of maintenance: is the pump easy to clean, assemble/disassemble?

## Wetted Materials

- What media will you be pumping?
- What is the chemical compatibility of the elastomer?
- What are the temperature limits of the wetted material and elastomer?
- How abrasive is the media being pumped?
- Do diaphragm configurations affect flow?

## Distributors

- Is your distributor local?
- Can the distributor fully support your fluid transfer needs?
- Are they a full-stocking, full-service distributor?
- How good is delivery? Is it less than 3 weeks?
- Is the distributor formally educated in specifying and maintaining your system?
- How are the services and repair capabilities of the distributor?
- Does the distributor do local training for your staff?
- How responsive is the distributor to your needs?

## Resources

- [wildenpump.com](http://wildenpump.com)
- Locating your Authorized Wilden Distributor: [wildendistributor.com](http://wildendistributor.com)
- Engineering, Operations and Maintenance Manuals: [wildenpump.com](http://wildenpump.com) > Support > Manuals (EOMs)
- Cavitation and Friction Guide & Safety Supplement: [wildenpump.com](http://wildenpump.com) > Support > Literature
- Electronic Chemical Resistance Guide: [wildenpump.com](http://wildenpump.com) > Support > Chemical Guide
- Troubleshooting: [wildenpump.com](http://wildenpump.com) in the Support section (Troubleshooting)

**WILDEN TECHNICAL SUPPORT:** Hours of operation: 8:00 am – 5:00 pm (PST)  
Ph. +1 (909) 783-3440 • E-mail: [techsupport@wildenpump.com](mailto:techsupport@wildenpump.com)

## Where Innovation Flows

**WILDEN®**

PSG  
22069 Van Buren Street  
Grand Terrace, CA 92313-5651 USA  
P: +1 (909) 783-3440 • F: +1 (909) 783-3440  
wildenpump.com

PSG reserves the right to modify the information and illustrations contained in this document without prior notice. This is a non-contractual document. 09-2017

Authorized PSG Partner:

**airpumping.co.uk**

*est. 1979*

Unit 16, Uppminster Trading Park, Warley St, Uppminster, Essex, RM14 3PJ, ENGLAND